

Specification for Approval

Product Name: 240W Linear Non-isolated Driver

Product Model: N7C-240M260A12

Rev: B.2

Address: Xili Songbai Road 1061, Nanshan District, Shenzhen City, Guangdong, China

Tel: 0755-27657000

FAX: 755-27657908

E-mail: info@mosopower.com

Web Site: <http://www.mosopower.com>

Prepared By	Checked By	Approved By

Specification for Approval

Product Name: 240W Linear Non-isolated Driver

Product Model: N7C-240M260A12

Rev: B.2

CUSTOMER AUTHORIZED SIGNATURE		
Tested By	Checked By	Approved By
(Company seal)Return one copy to MOSO with approved signature and company seal.		

Address:XiLiSongbai Road 1061, Nanshan District, Shenzhen City, Guangdong, China

Tel: 0755-27657000

FAX: 755-27657908

E-mail:info@mosopower.com

Web Site:<http://www.mosopower.com>

Prepared By	Checked By	Approved By

Description

The N7C series is specifically designed for industrial lighting applications, non-isolated design, operating in constant current with high power factor and a universal input voltage range of 108–380Vac. With 0-10V/PWM/ resistance dimming. The compact housing and high efficiency allow the drivers to operate with high reliability, while featuring input surge, output over voltage, short circuit and over temperature protection.



Product Features

- n Universal input voltage: 108–380Vac;
- n Rated Input voltage: 120–347Vac;
- n Constant current design, Efficiency up to 95%;
- n 3-in-1 dimmable: 0–10V / PWM / Resistor;
- n Dim-to-off without afterglow (optional);
- n High surge protection: DM: 6KV, CM: 6KV;
- n 12V/0.2A auxiliary power supply;
- n Output and Dimming Signal Isolating;
- n Protections: SCP / OVP / OTP;
- n 5 years warranty;

Application

Linear high bay light
 Flood light
 Wall Pack light
 Shoebox light

Models

Model Number	Input Voltage Range (Vac)	Max Output Power (W)	Output Voltage Range (Vdc)	Output Current Adjustable Range (A)	Default Current(A)	Eff. (Typ.)	PF(Typ.)	THD(Typ.)
N7C-240M260A12	108–380	240	180–260	0.77–1.11	1.0	95%	0.97	10%

Notes:

[1]. All specifications are measured at 25°C ambient temperature, input voltage 277Vac, and the typical value tested at full load, if no specific note.

Input Specifications

Parameter	Min	Typ.	Max	Notes
Input Voltage Range	108Vac	-	380Vac	
Rated Input voltage	120Vac	-	347Vac	Refer to Output Power vs. Input Voltage curve
Input Frequency AC	47Hz	50/60Hz	63Hz	
Max Input Current	-	-	2.8A	120Vac & 100% load
Max Input Power	-	-	270W	120Vac & 100% load
Leakage Current	-	-	0.75mIU	UL 8750; 347Vac/60Hz
Inrush Current	-	-	60A	120Vac, 100% load
Inrush Current	-	-	100A	220Vac, 100% load
Inrush Current	-	-	145A	347Vac, 100% load
Power Factor (PF)	0.90	0.97		120-347Vac , 50/60Hz , 80%-100% load
Total Harmonic Distortion (THD)	-	10%	20%	120-277Vac , 50/60Hz , 80%-100% load
MCB(B16)	-	7	-	220Vac; 100%load

Output Specifications

Parameter	Min	Typ.	Max	Notes
Output Voltage Range	180Vdc	-	260Vdc	
Open Circuit Voltage	-	-	310Vdc	
Output Current Range	0.77A	-	1.11A	Adjustable output current with potentiometer
Full Power Current Range	0.92A	-	1.11A	$P=U \cdot I=240W$, 100%load
Current Accuracy	-8%	-	+8%	
Total Output Current Ripple	-	10%	15%	20MHz BW full load & LED load the LED load ripple is slightly different for different LEDs
Startup Overshoot Current	-	-	10%	120-347Vac full load condition, LED load
Auxiliary Source Output Voltage	10.8V	12V	13.8V	
Auxiliary Source Output Current	-	-	200mA	
Line Regulation	-5%	-	+5%	25°C±10°C ambient temperature, input changes from 120Vac to 347Vac
Load Regulation	-5%	-	+5%	Load varies from 70% to 100% with 120-347Vac Input at 25°C±10°C ambient temperature
Turn-on Delay Time	-	-	1s	120Vac, 100% load
Turn-on Delay Time	-	-	1s	277Vac, 100% load
Turn-on Delay Time	-	-	1s	347Vac, 100% load

General Specifications

Parameter	Min	Typ.	Max	Notes
Efficiency@120Vac	91%	92%	-	100% load, No load of auxiliary source
Efficiency@277Vac	92%	93%	-	100% load, No load of auxiliary source
Efficiency@347Vac	93%	95%	-	100% load, No load of auxiliary source
Mean Time Between Failure	-	200Khours	-	25°C±10°Cambient temperature , 230Vac , 80% load condition (MIL-HDBK-217/SR-332)
Lifetime	-	50Khours	-	230Vac & 100% load , Tc 80°C , refer to lifetime vs. case temperature curve
Operating Tc for Safety Tc_s	-40°C	-	+90°C	
Operating Tc for Warranty Tc_w	-40°C	-	+80°C	5-year warranty shell temperature, humidity: 10% to 90% RH, Non-condensing
Storage Temperature Ta	-40°C	-	+85°C	Humidity: 5% to 95% RH, Non-condensing
Altitude	-60m	-	4000m	
Over Temperature Protection Tc	90°C	95°C	100°C	Decreases output current, returning to normal after over temperature is removed.
Short Circuit Protection	-	-	15W	Constant current mode. The output shall return to normal when the fault condition is removed.
Dimensions (L*W*H)	192*53*34mm			
Net Weight	740±50g/PCS			
Package (L*W*H)	500*310*160mm; 24PCS/Ctn., Gross Weight: 18Kg			

Dimming

Parameter	Min	Typ.	Max	Notes
Absolute Maximum Voltage	-	10V	15V	On the Vdim (+) Pin
Source Current on Vdim (+)Pin	-	100uA	200uA	
Dimming Range	10% I _{o max}	-	100% I _{set}	I _{set} =0.77-1.10A
Suggest Dimming Input 0-10V	0V	-	10V	
Turn-on Voltage	1.0V	-	1.3V	
Turn-off Voltage	0.6V	-	1.0V	
PWM in High Level	9.7V	-	10.3V	
PWM in Low Level	0V	-	0.3V	
PWM in Frequency Range	1KHz	-	2KHz	
PWM in Duty Cycle	1%	-	99%	
Turn-on Duty Cycle	10%	-	13%	
Turn-Off Duty Cycle	6%	-	10%	
Resistor Range	0	-	100KΩ	

Safety Specification

Parameter	Min	Typ.	Max	Notes
Dielectric Strength (Input-Ground)	-	1700Vac	-	60s , Current not exceeding 5mA
Dielectric Strength (Input-Dimming)	-	1700Vac	-	60s , Current not exceeding 5mA
Grounding Resistance	-	-	0.1Ω	25°C±10°C Ambient Temperature, pass 30A Current, 120s.
Insulation Resistance	10MΩ	-	-	Input -PE, 500Vdc/60s/25°C

Safety Compliance

Safety Category	Standards	Approved	Notes
CCC	GB19510.1,GB19510.14		
CE	EN61347-1, EN61347-2-13, EN62493		
ENEC	EN61347-1, EN61347-2-13, EN62384		
CB	IEC61347-1, IEC61347-2-13		
BIS	IS 15885(PART 2/SEC 13)		
UL	UL 8750	√	
CUL	CSA C22.2 No.250.13	√	
KC	K61347-1, K61347-2-13		
PSE	J61347-1, J61347-2-13		
SAA	AS/NZS IEC 61347.2.13		
SAA	AS/NZS 61347.1		

EMC Compliance

EMC Category	Standards	Approved	Notes
CCC	GB/T 17743, GB 17625.1		
CE	EN 55015		
CE	EN 61000-3-2, EN 61000-3-3		
CE	EN61000-4-2,3,4,5,6,11		
CE	EN 61547		
KC	K61547		
KC	K00015		
PSE	J55015		
FCC	FCC part 15	√	CLASS A
Surge Shock Immunity	ANSI/C82.77-5-2017		
	IEC/EN 61000-4-5		
Ringing Wave	IEC/EN 61000-4-12		
	ANSI/IEEE C62.41.2		

RoHS

Our products comply with reference to RoHS Directive (EU) 2015/863 amending 2011/65/EU.

Inrush Current

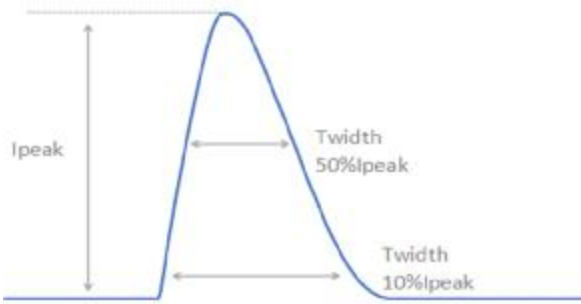

Vin	Ipeak	T(@10% of Ipeak)	T(@50% of Ipeak)
220Vac	100A	290µs	140µs

Output Voltage vs. Output Current

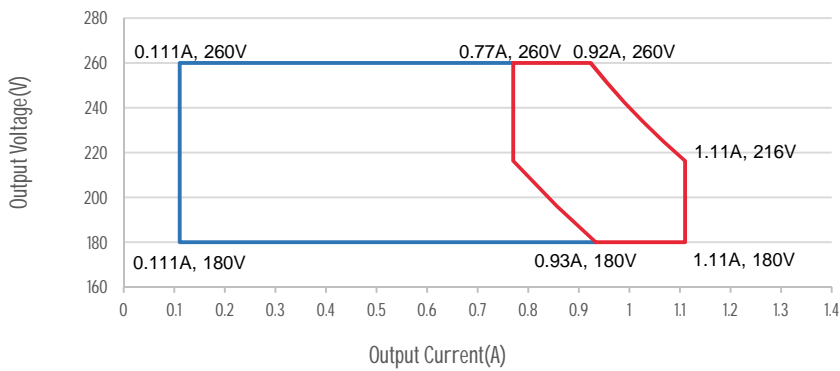

Red curve: good performance area

Output Power vs. Input Voltage

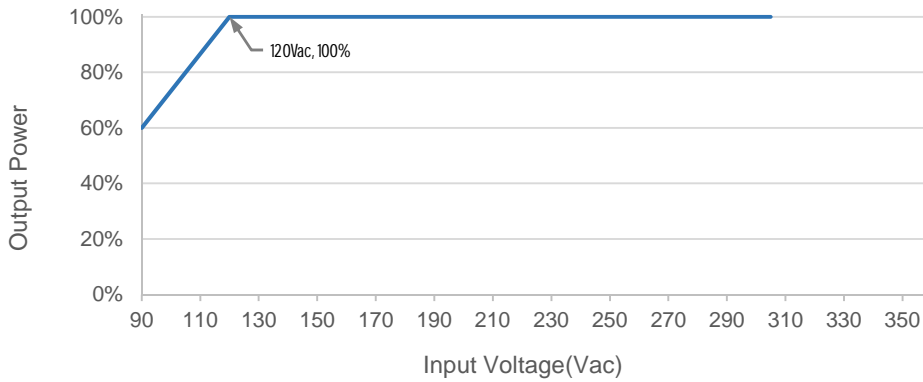

Efficiency vs. Load

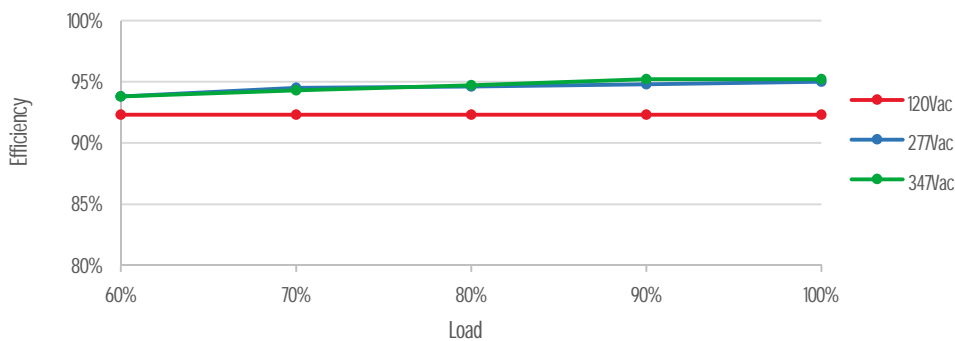

PF vs. Load

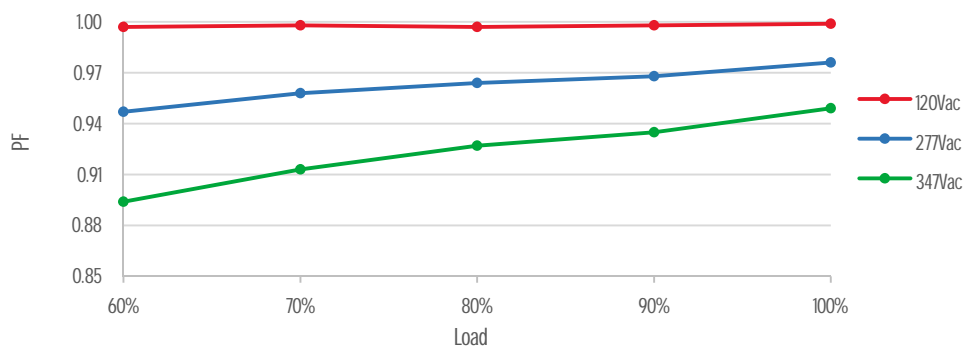

THD vs. Load

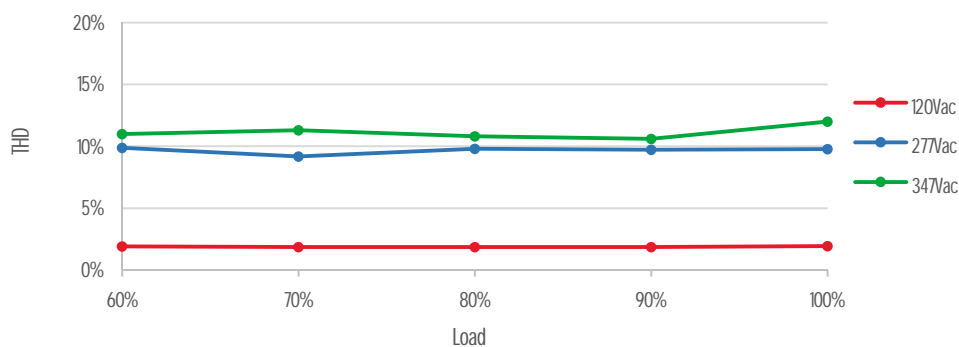

Output Power vs. Case Temperature

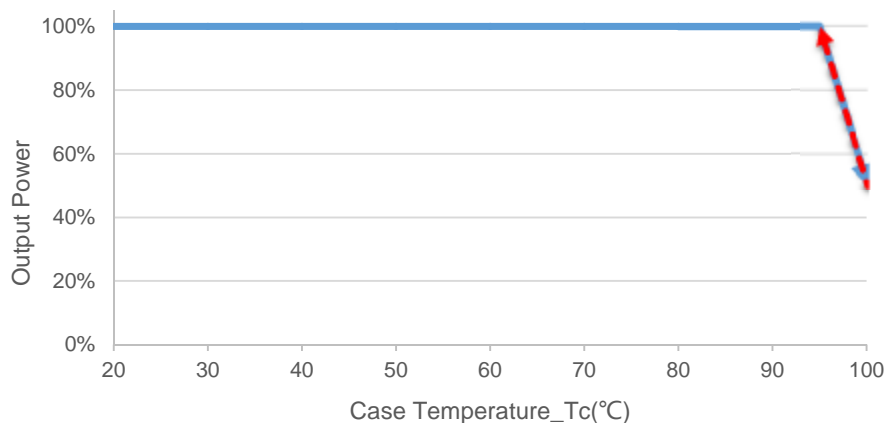

Lifetime vs. Case Temperature

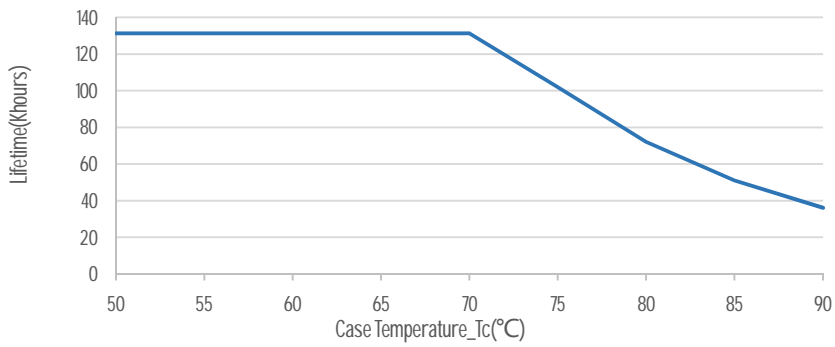

0-10V/PWM/Resistor Dimming

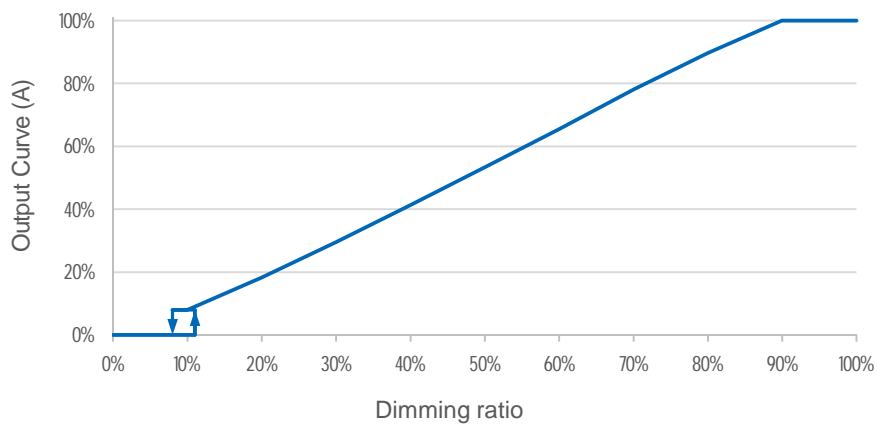

Mechanical Outline

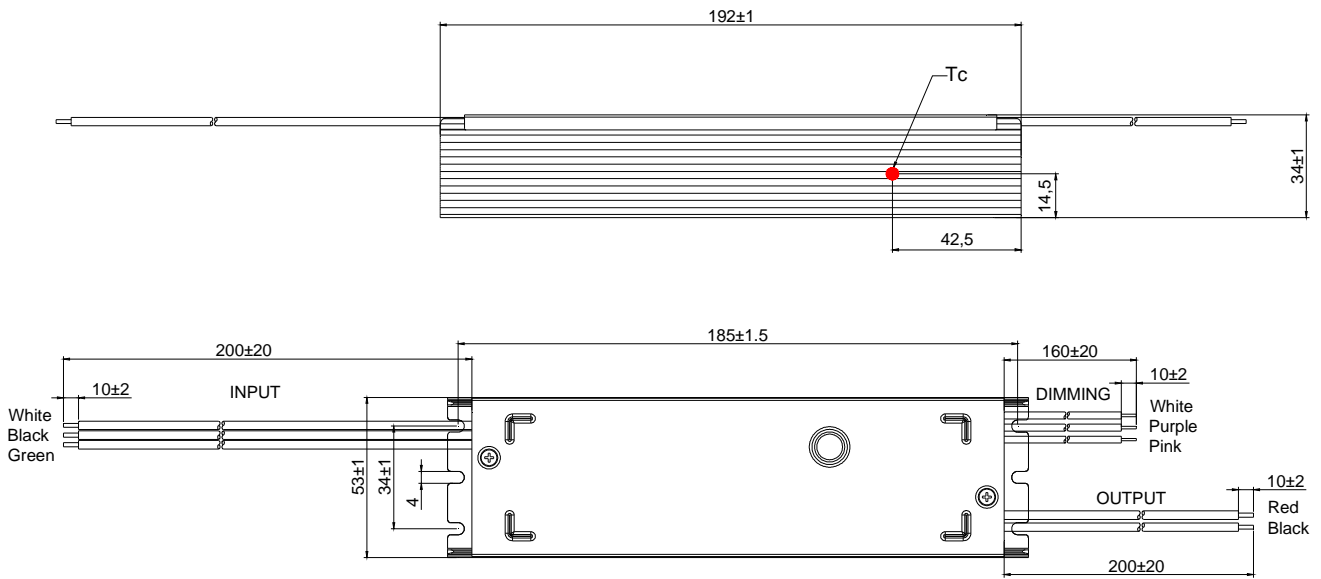

Notes:

- [1]. In order to meet the requirements of the "derating curve" and "maximum ambient temperature of 50 °C", it is necessary to add auxiliary heat dissipation devices with a recommended heat dissipation area of 380cm² and the volume is 115cm³; It is also necessary to add thermal conductive silicone grease between the heat sink and LED driver to ensure a tight fit with the auxiliary heat sink.
- [2]. The pressure resistance of LED beads and aluminum substrate should be greater than 2KVac.

Specification

Input	UL 1015 18AWG L=200±20mm Tin-dip length 10±2mm	UL
Output	UL 1015 18AWG L=200±20mm Tin-dip length 10±2mm	UL
Dimming	UL 1015 22AWG L=160±20mm Tin-dip length 10±2mm	UL

Version

A.1	First release	2024-02-26
B.2	ECL202403028	2024-03-13