

## Description

The U5 series is constant-current, NFC programmable and IP20 rated LED driver that operates from 176~305Vac input with excellent power factor. The NFC interface implemented enables an easy and safe way for programming LED drivers during the production process and in the field. The parameters can be transferred without powering on the LED driver. The U5 series supports timer dimming with three mode. The better thermal design and high efficiency enables the driver to operate with high reliability and extend product lifetime. Overall protection is provided against lightning surge, output over voltage, short circuit, and over temperature to ensure low failure rate.



## Product Features

- input voltage range: 176~305Vac;
- Constant power design;
- Adjust output current (AOC) by NFC or DALI-2 programmer ;
- Constant lumen output(CLO);
- 3 Timers dimming: Timing; Virtual Midnight; Self-Adaptive;
- DALI-2 certified ,Support Part 251, 252, 253;
- Standby power consumption<0.5W;
- Suitable for luminaires with protection Class I and II;
- Surge protection: 6KV line-line, 10KV line-earth(Class I);
- Protections: Input OVP/UVP; Output SCP/OVP/OTP;
- IP20 design for indoor and outdoor applications ;
- 5 years warranty.

## Application

Street and urban lighting  
Industrial lighting,

## Models

Model Number	Input Voltage Range(Vac)	Max Output Power(W)	Output Voltage Range(Vdc)	Full Power Output Current Range(A)	Default Current(A)	Eff.(Typ.)	PF(Typ.)	THD
U5-200D300	176-305	200	143-300	0.67-1.05	0.70	94%	0.98	5%

### NOTES:

- [1]. D means DALI-2&Timer dimming.  
[2]. All specifications are measured at 25°C ambient temperature, input voltage 230Vac, and the typical value tested by full load, if no specific note.

## Input Specifications

Parameter	Min	Typ.	Max	Notes
Input Voltage	176Vac	220~240Vac	305Vac	
Input Frequency AC	47Hz	50/60Hz	63Hz	
Max Input Current	-	-	1.60A	176Vac&Full Load
Max Input Power	-	-	240W	176Vac&Full Load
Leakage Current	-	-	0.70mA	IEC 60598-1;240Vac/60Hz
Inrush Current	-	-	75A	230Vac&Full Load, Cold Start
Standby Power Consumption	-	-	0.5W	230Vac&50Hz
Power Factor(PF)	0.96	0.98	-	220-240Vac, 50-60Hz, 100% Load
Power Factor(PF)	0.91	0.93	-	220-240Vac, 50-60Hz, 60%-100% Load
Total Harmonic Distortion(THD)	-	5%	10%	220-240Vac, 50-60Hz, 100% Load
Total Harmonic Distortion(THD)	-	-	10%	220-240Vac, 50-60Hz, 60%-100% Load
MCB(B16)	-	3	-	230Vac

## Output Specifications

Parameter	Min	Typ.	Max	Notes
Output Voltage Range	143Vdc	-	300Vdc	The full power cannot be lower than 191Vdc
Open Circuit Voltage	-	-	380Vdc	The open circuit protection is locked, and the AC needs to be powered on again
Output Current Range	70% $I_{set}$	-	100% $I_{set}$	The NFC or Dali programmer regulates the $I_{set}$ current
Full Power Current Range	0.67A	-	1.05A	
Current Accuracy	-5% $I_{set}$	-	+5% $I_{set}$	$I_{set}>0.70A$
Total Output Current Ripple (pk-pk)	-	5%	10%	20MHz BW, full load& LED load, the ripple would be tiny different under different LED load.
Startup Overshoot Current	-	-	10%	220~240Vac &100% Load, load is LED
Line Regulation	-1%	-	+1%	25°C±10°C ambient temperature, input voltage changes from 200Vac to 240Vac.
Load Regulation	-3%	-	+3%	25°C±10°C ambient temperature, Input Voltage 230Vac, load changes from 60% to 100%.
Turn-on Delay Time	-	-	1.5s	240Vac, 100%Load
Isolation input to output	-	Double	-	
Output Pst <sup>LM</sup>	-	-	0.01	In entire operating window
Output SVM	-	-	0.01	In entire operating window

## General Specifications

Parameter	Min	Typ.	Max	Notes
Efficiency@230Vac I <sub>o</sub> =0.67A I <sub>o</sub> =1.05A	92% 91%	94% 93%	- -	Measured at full load and 25 °C ambient temperature
Mean Time Between Failure	-	200Khours	-	25°C±10°C ambient temperature, 230Vac,80% Load (MIL-HDBK-217F/SR-332)
Life Time	-	50Khours 100Khours	-	T <sub>a</sub> =50°C, T <sub>c</sub> =90°C, 230Vac&100% Load T <sub>a</sub> =40°C, T <sub>c</sub> =80°C, 230Vac&100% Load
Operating Temperature	-40°C	-	+50°C	230Vac&100% load; Humidity:10%RHto95%RH Non-condensing
Operating T <sub>c</sub> for Safety T <sub>c_s</sub>	-40°C	-	+90°C	Humidity:10%RHto95%RH Non-condensing
Operating T <sub>c</sub> for Warranty T <sub>c_w</sub>	-40°C	-	+90°C	5 years warranty case temperature; Humidity:10%RHto95%RH Non-condensing
Storage Temperature	-40°C	-	+85°C	Humidity: 5% to 50% RHNo condensation
Altitude	-60m	-	4000m	
Input Under voltage Protection	130Vac	150Vac	170Vac	When the input voltage is lower than the protection voltage, the driver will turn off automatically. When the input voltage exceeds the recovery voltage, the driver will restart automatically.
Input Over voltage Protection	305Vac	325Vac	345Vac	The input voltage exceeds the protection voltage, the output is turned off. Automatic recovery. When the input voltage falls below the recovery voltage, the drive will restart.
Output over voltage Protection	-	-	-	AC needs to be powered on again
Over Temp Protection T <sub>c</sub>	-	95°C	-	T <sub>c</sub> ; 230Vac&100% load
Short Circuit Protection	-	-	-	self-recovery after 30 seconds
Dimensions (L*W*H)mm	171*101*41mm			
Net Weight	1000±100g/PCS			
Package (L*W*H)mm	414*381*183mm; 18PCS/ctn, Gross Weight: 22Kg			

## DALI Specifications

Parameter	Min	Typ.	Max	Notes
DALI-2 (High Voltage Level)	9.5V	16V	22.5V	
DALI-2 (Lower Voltage Level)	-6.5V	0V	6.5V	Return terminal is "DA-"
DALI-2 (Dimming Output Range)	10% I <sub>set</sub>	-	100% I <sub>set</sub>	I <sub>set</sub> =0.67~1.05A
DALI-2 (Sink Current)	-	-	2.0mA	

## Safety Specification

Parameter	Min	Typ.	Max	Notes
Dielectric Strength(Input-Output)	-	3750Vac	-	60s, Current not exceeding 5mA
Dielectric Strength(Input-Ground)	-	3750Vac	-	60s, Current not exceeding 5mA
Dielectric Strength(Output-Ground)	-	1650Vac	-	60s, Current not exceeding 5mA
Insulation Resistance	10MΩ	-	-	Input-Output, Input-PE, Output-PE, 500Vdc/60s/25°C/70%RH

## Safety Compliance

Safety Category	Standards	Approved	Notes
CCC	GB19510.1,GB19510.14		
CE	EN61347-1, EN61347-2-13, EN62493	√	
ENEC	EN61347-1, EN61347-2-13, EN62384	√	
CB	IEC61347-1, IEC61347-2-13	√	
BIS	IS 15885(PART 2/SEC 13)		
UL	UL 8750		
CUL	CSA C22.2 No.250.13		
KC	K61347-1, K61347-2-13		
PSE	J61347-1, J61347-2-13		
SAA	AS/NZS IEC 61347.2.13		
SAA	AS/NZS 61347.1		

## EMC Compliance

EMC Category	Standards	Approved	Notes
CCC	GB/T 17743, GB 17625.1		
CE	EN 55015	√	
CE	EN 61000-3-2, EN 61000-3-3	√	
CE	EN61000-4-2,3,4,5,6,11	√	
CE	EN 61547	√	
KC	K61547		
KC	K00015		
PSE	J55015		
FCC	FCC part 15		
Surge Shock Immunity	ANSI/C82.77-5-2017		
Ringing Wave			

## RoHS

Our products comply with RoHS Directive (EU) 2015/863 amending Annex II to Directive 2011/65/EU.

**Inrush Current**

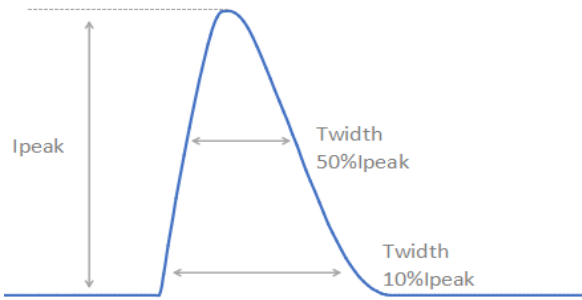

$V_{in}$	$I_{peak}$	$T(@10\% \text{ of } I_{peak})$	$T(@50\% \text{ of } I_{peak})$
220Vac	60A	900uS	500uS

**Output Voltage vs. Output Current**

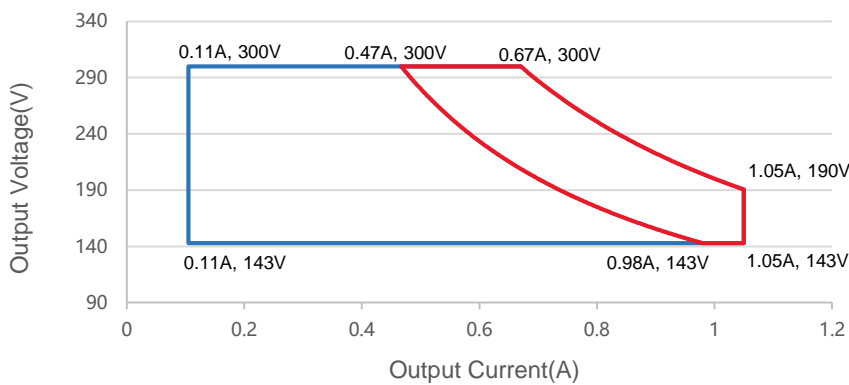

Red curve: good performance area

**Output Power vs. Input Voltage**

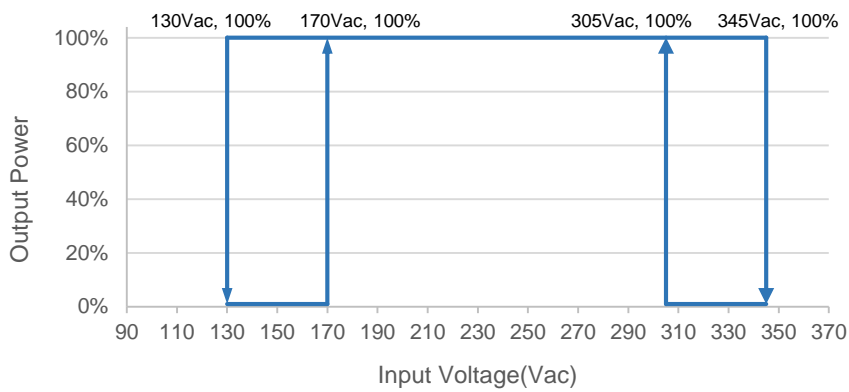

**Efficiency vs. load**

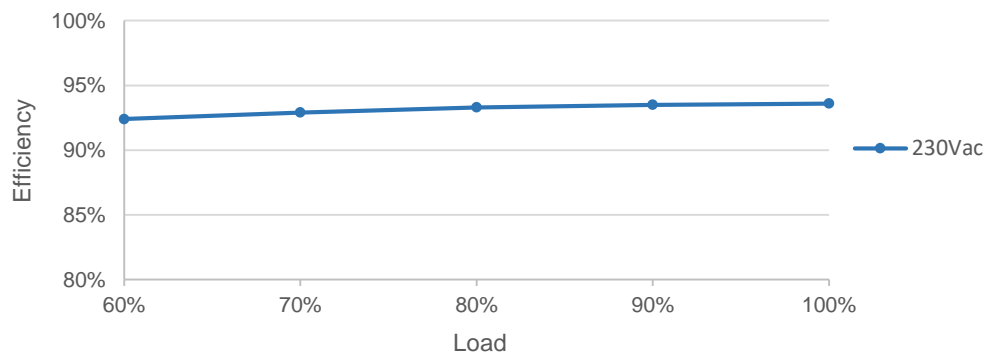

**PF vs. Load**

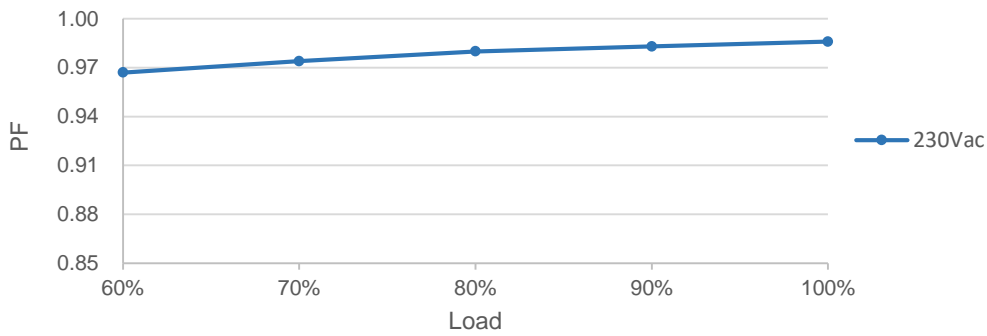

**THD vs. Load**

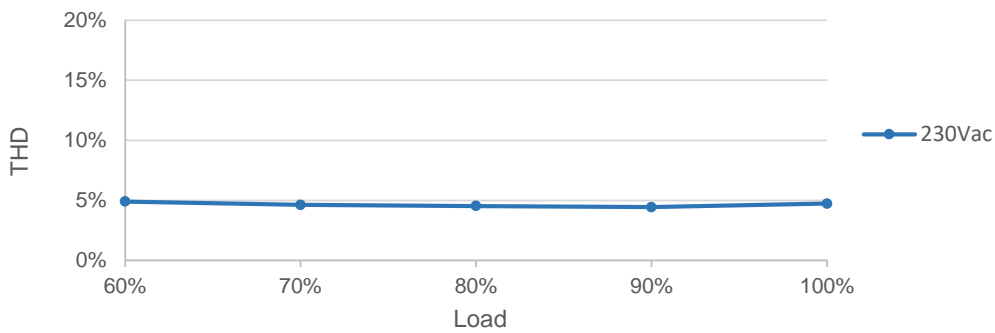

**Output Power vs. Ambient Temperature**

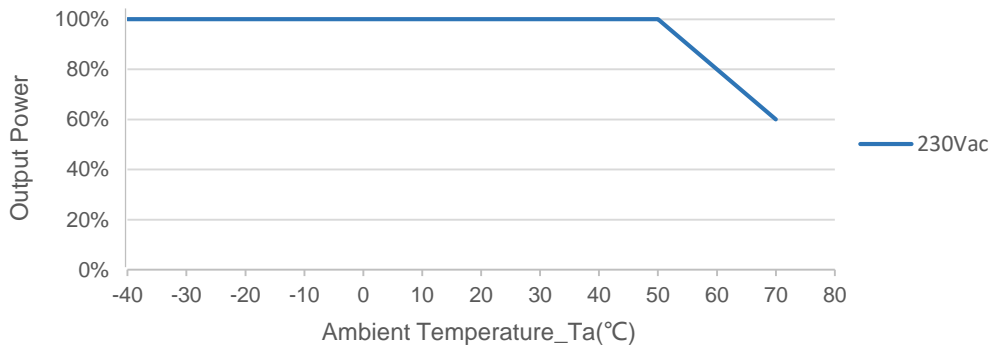

**Over Temperature Protection Curve**

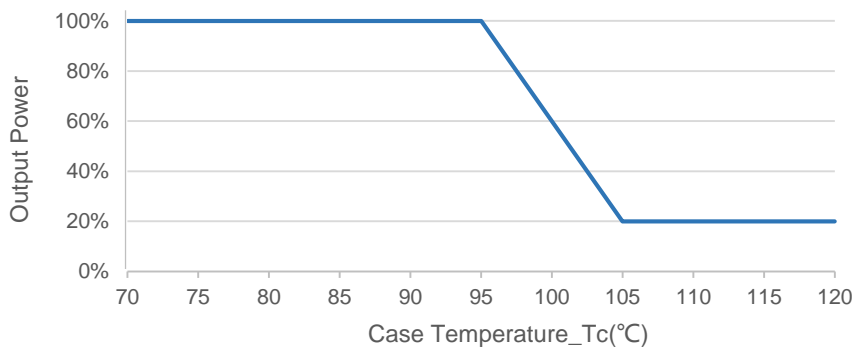

Notes: returning to normal after over temperature is removed.

### Lifetime vs. Case Temperature

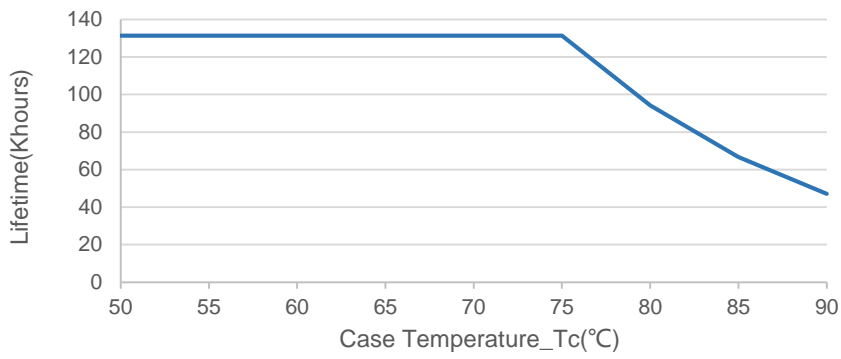

### DALI-2 Dimming

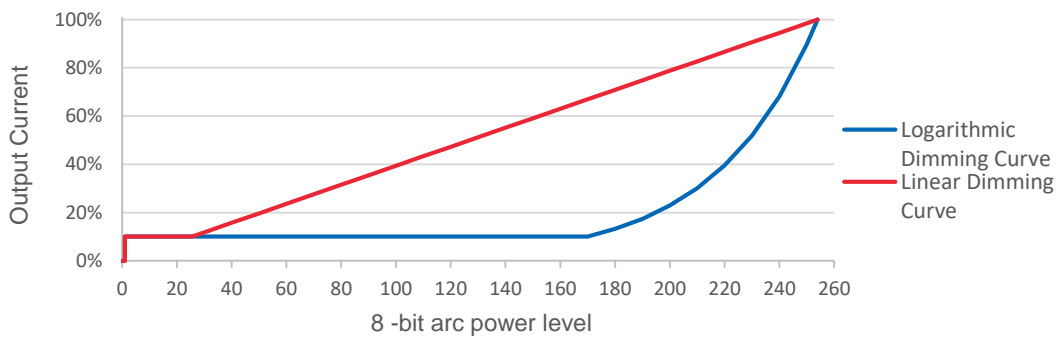

Note: Factory Default Output Logarithmic Curve

## Programming Link (DALI-2)

### Programming mode 1

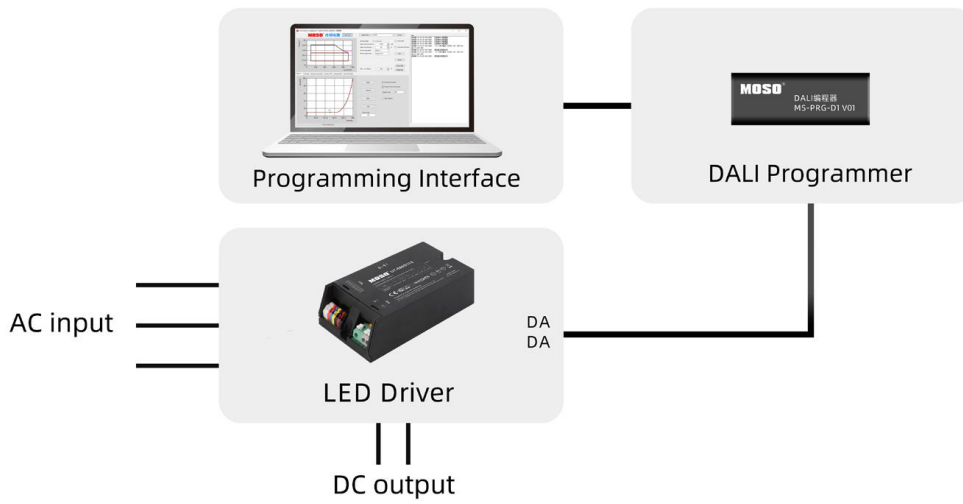

### Programming mode 2



#### Notes:

1. The driver does not need to be powered on during the programming process.
2. Please refer to MS-PRG-D1 or MS-PRG-N1 (Programmer) datasheet for details.
3. Applicable to FEIG programmer: ISC PRH101 and CPR30-USB



## Time Dimming

Time-controlled dimming is divided into three modes: Timing dimming, Virtual Midnight dimming, Self-Adaptive dimming.

### Timing Dimming

After the driver is powered on, the driver will change in sequence according to the programmed seven periods, and maintain the brightness of timer 7 after running to the last timer.

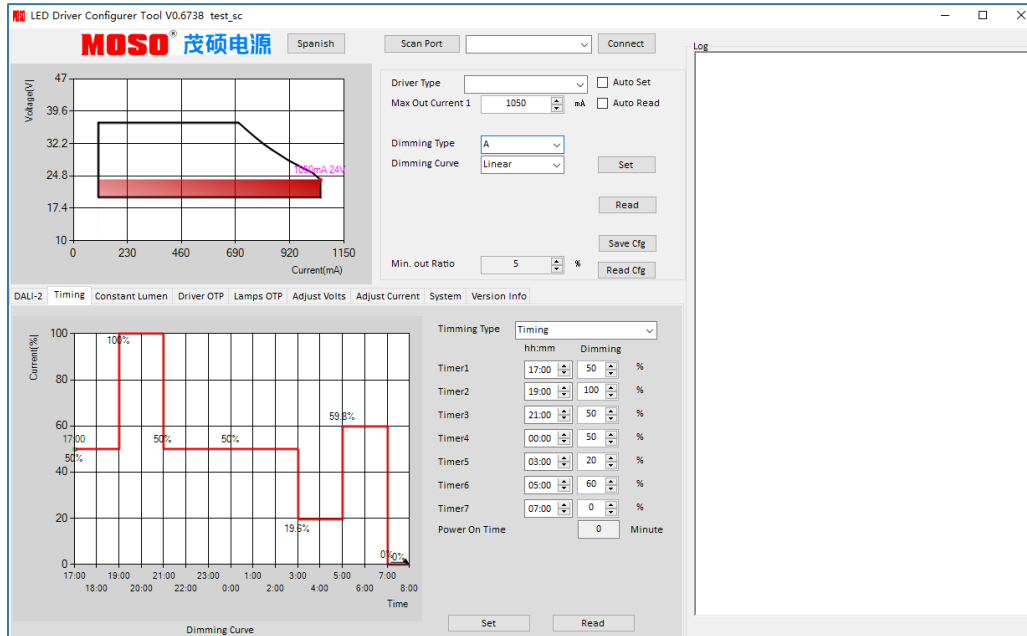

### Virtual Midnight Dimming

The power-on point and power-off point usually correspond to sunset time and sunrise time respectively, so their midpoint is the virtual midnight point. The driver will automatically sample the corresponding effective working days according to the reference days set by the customer, and automatically adjust the dimming curve according to the average working hours.

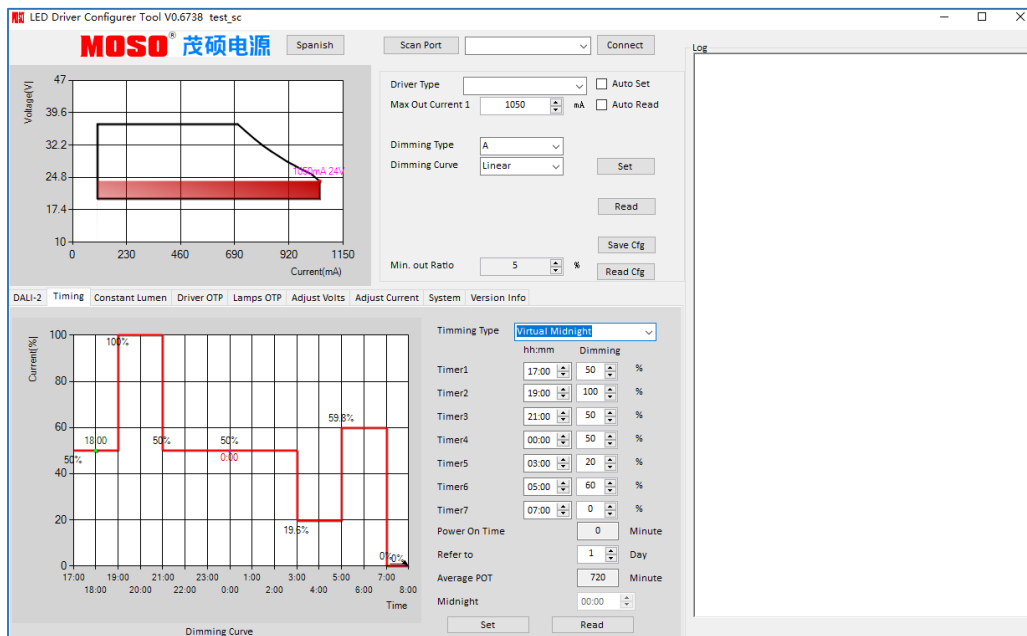

◆ Self - Adaption Dimming

Depending on the customer setup, the drive automatically calculates the effective mean operating time and calculates the ratio to the customer's set parameter time length, automatically making this computational ratio adjustment at each step.

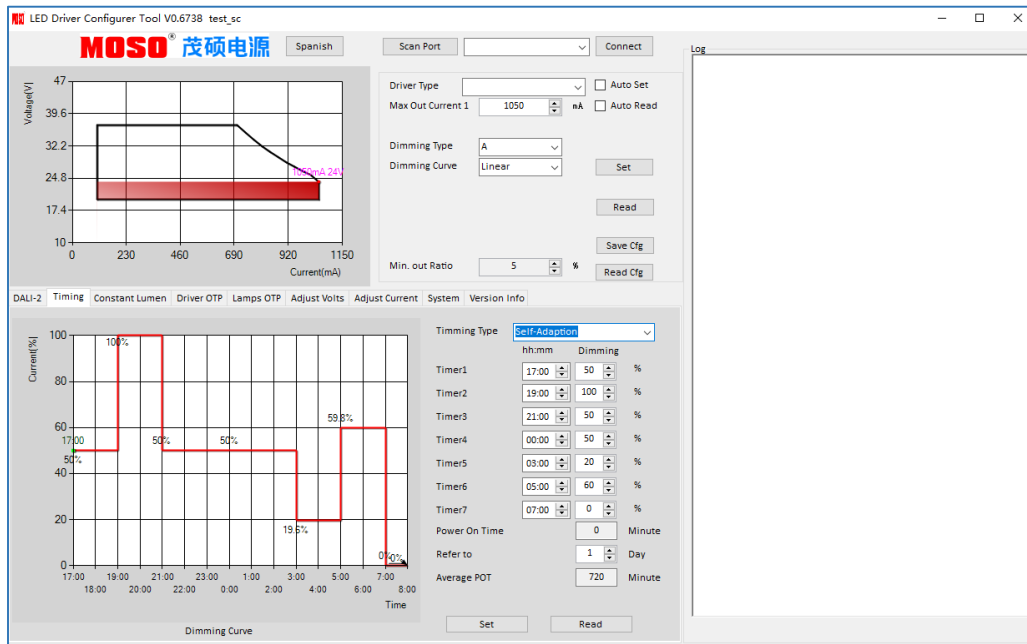

Note: Drives were judged only as valid working days if they were greater than 4 hours and less than 24 hours, and an effective on-off cycle was considered a day

CLO

CLO: With the increase of cumulative illumination time of LED light source, the LED driving can automatically increase its output current, and then realize the increasing of light flux output of LED light source with the increase of cumulative illumination time to achieve the purpose of light decay compensation. Thus the road surface illumination level is basically constant.

Note: Compensated current values are calculated as a percentage based on IMAX. The minute setting column is only used by the customer to test the CLO function. The driver will reset the hour setting column after power failure and power on again. The "ENABLE check box" must be checked to enable the CLO function

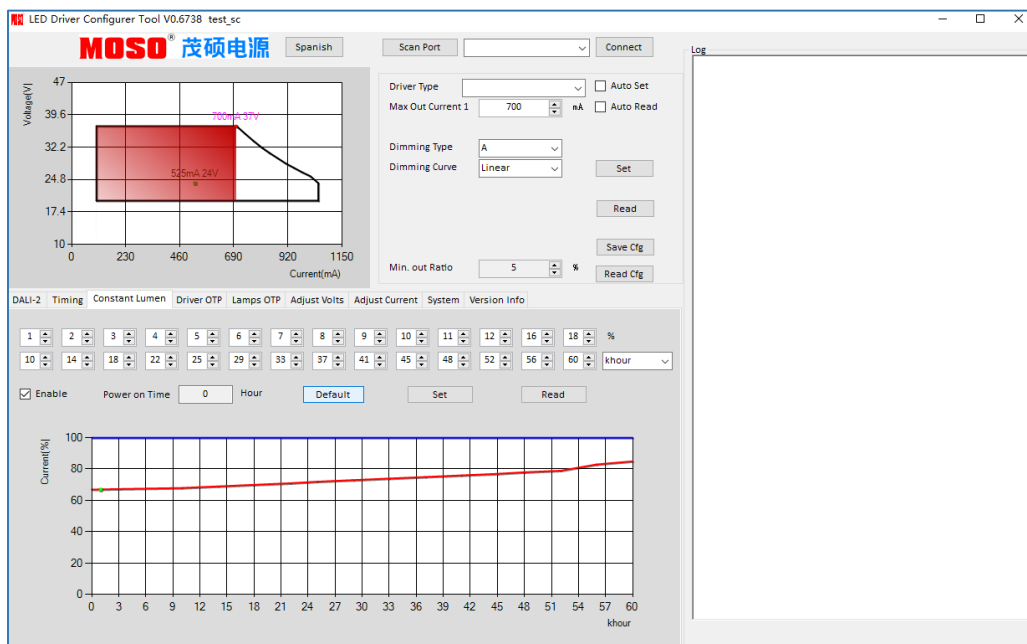

**Mechanical Outline**

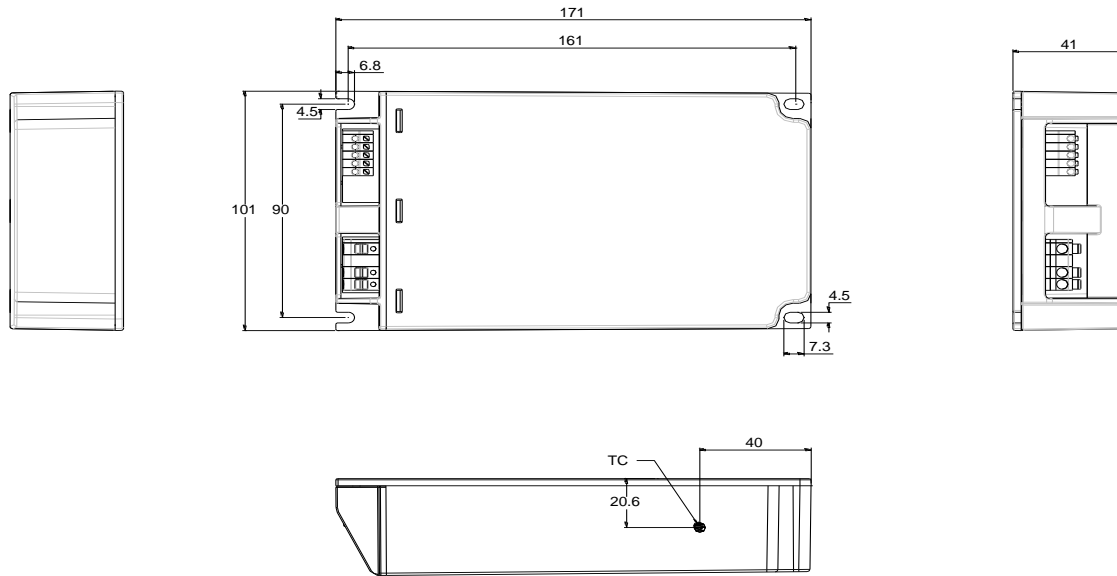

**Notes:** EQUI pin connects to ground wire and metal housing of luminaries for Class I applications, and to metal housing for Class II applications.

**Connections**

<b>Input (L,N,G)</b>	Wire Cross-section 0.5 mm <sup>2</sup> - 1.5 mm <sup>2</sup> /20 AWG - 16 AWG	Push-in at 45°angle, solid and stranded wire
<b>Output</b>	Wire Cross-section 0.2 mm <sup>2</sup> - 1.5 mm <sup>2</sup> /22 AWG - 16 AWG	Push-in at 45°angle, solid and stranded wire
<b>Dimming</b>	Wire Cross-section 0.2 mm <sup>2</sup> - 1.5 mm <sup>2</sup> /22 AWG - 16 AWG	Push-in at 45°angle, solid and stranded wire

**Label**

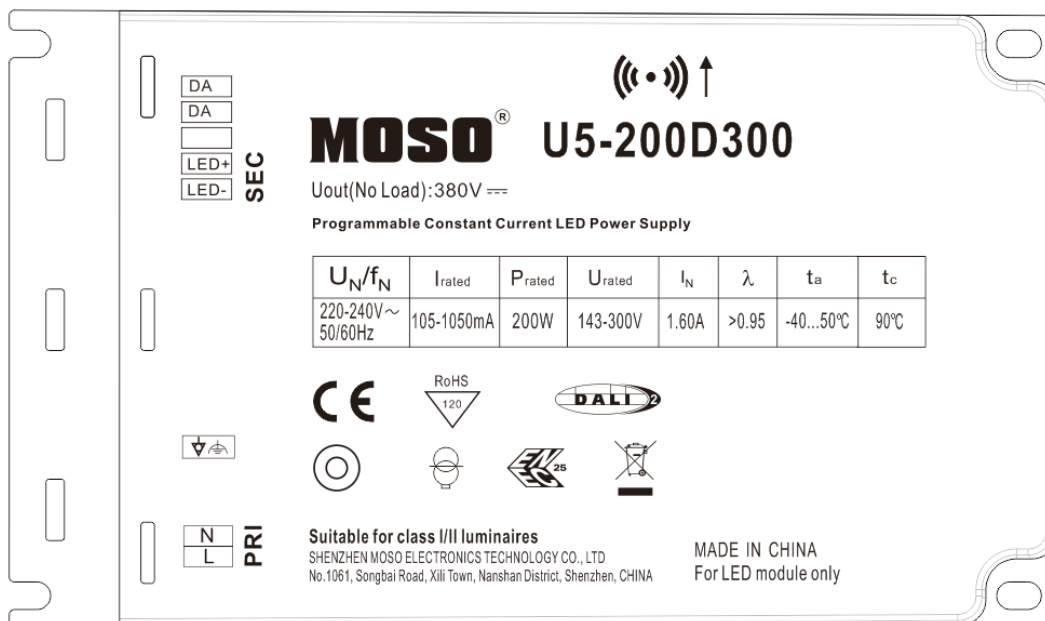

For carton label(100\*60mm)

<div style="border: 1px solid red; padding: 2px; display: inline-block;">打印客户提供型号</div>	MOSO Production No.:	9110005495 	Q'ty:	18 PCS 
	MOSO Part No.:	1022001342	N.W.:	KG
	Model:	03-83-089(U5-200D300)	G.W.:	KG
	Purchase Order No.:		Date Code:	2024-08-21
	Initial Current:	0.7A	<b>MOSO</b> <sup>®</sup> 	
	CTN No.:	91100054950001 		

在MOSO标准上更改客户型号，未注明按实际出货打印

**Version**

A.1	First release	2024-09-14

# Specification for Approval

Product Name: 200W Class I/II LED Driver

Product Model: U5-200D300

Rev : A.1

Address: XiLi Songbai Road 1061, Nanshan District, Shenzhen City, Guangdong, China

Tel: 0755-27657000

FAX: 0755-27657908

E-mail: info@mosopower.com

Web Site: <http://www.mosopower.com>

Prepared By	Checked By	Approved By

## Specification for Approval

Product Name: 200W Class I/II LED Driver

Product Model: U5-200D300

Rev: A.1

CUSTOMER AUTHORIZED SIGNATURE		
Tested By	Checked By	Approved By
(Company seal)Return one copy to MOSO with approved signature and company seal.		

Address: XiLi Songbai Road 1061, Nanshan District, Shenzhen City, Guangdong, China

Tel: 0755-27657000

FAX: 0755-27657908

E-mail:info@mosopower.com

Web Site: <http://www.mosopower.com>

Prepared By	Checked By	Approved By