

## Description

The U5 series is constant-current, NFC programmable and IP20 rated LED driver that operates from 176~305Vac input with excellent power factor. The NFC interface implemented enables an easy and safe way for programming LED drivers during the production process and in the field. The parameters can be transferred without powering on the LED driver. The U5 series supports timer dimming with three mode . The better thermal design and high efficiency enables the driver to operate with high reliability and extend product lifetime. Overall protection is provided against lightening surge, output over voltage, short circuit, and over temperature to ensure low failure rate.



## Product Features

- Input voltage range: 176~305Vac;
- Constant power design;
- Adjust output current (AOC) by NFC or DALI-2 programmer ;
- Constant lumen output(CLO);
- 3 Timers dimming: Timing; Virtual Midnight; Self-Adaptive;
- DALI-2 certified ,Support Part 251, 252, 253;
- Standby power consumption<0.5W;
- Suitable for luminaires with protection Class I and II;
- Surge protection: 6KV line-line, 10KV line-earth(Class I);
- Protections: Input OVP/UVP; Output SCP/OVP/OTP;
- IP20 design for indoor and outdoor applications ;
- 5 years warranty.

## Application

Street and urban lighting  
Industrial lighting.

## Models

| Model Number | Input Voltage Range(Vac) | Max Output Power(W) | Output Voltage Range(Vdc) | Full Power Output Current Range(A) | Default Current(A) | Eff.(Typ.) | PF(Typ.) | THD(Typ.) |
|--------------|--------------------------|---------------------|---------------------------|------------------------------------|--------------------|------------|----------|-----------|
| U5-040D060   | 176-305                  | 40                  | 28-60                     | 0.67~1.05                          | 0.70               | 91%        | 0.97     | 5%        |

### NOTES:

- [1]. D means DALI-2&Timer dimming.  
[2]. All specifications are measured at 25°C ambient temperature, input voltage 230Vac, and the typical value tested by full load, if no specific note.

## Input Specifications

| Parameter                      | Min    | Typ.       | Max    | Notes                              |
|--------------------------------|--------|------------|--------|------------------------------------|
| Input Voltage                  | 176Vac | 220~240Vac | 305Vac |                                    |
| Input Frequency AC             | 47Hz   | 50/60Hz    | 63Hz   |                                    |
| Max Input Current              | -      | -          | 0.3A   | 176Vac&Full Load                   |
| Max Input Power                | -      | -          | 50W    | 176Vac&Full Load                   |
| Leakage Current                | -      | -          | 0.70mA | IEC 60598-1;240Vac/60Hz            |
| Inrush Current                 | -      | -          | 50A    | 230Vac&Full Load, Cold Start       |
| Standby Power Consumption      | -      | -          | 0.5W   | 230Vac&50Hz                        |
| Power Factor(PF)               | 0.95   | 0.97       | -      | 220-240Vac, 50-60Hz, 100% Load     |
| Power Factor(PF)               | 0.92   | 0.94       | -      | 220-240Vac, 50-60Hz, 60%-100% Load |
| Total Harmonic Distortion(THD) | -      | 5%         | 10%    | 220-240Vac, 50-60Hz, 100% Load     |
| Total Harmonic Distortion(THD) | -      | -          | 15%    | 220-240Vac, 50-60Hz, 60%-100% Load |
| MCB(B16)                       | -      | 12         | -      | 230Vac                             |

## Output Specifications

| Parameter                           | Min           | Typ. | Max            | Notes   |
|-------------------------------------|---------------|------|----------------|---|
| Output Voltage Range                | 28Vdc         | -    | 60Vdc          | The full power cannot be lower than 38Vdc   |
| Open Circuit Voltage                | -             | -    | 100Vdc         | The open circuit protection is locked, and the AC needs to be powered on again              |
| Output Current Range                | 70% $I_{set}$ | -    | 100% $I_{set}$ | The NFC or Dali programmer regulates the $I_{set}$ current                                  |
| Full Power Current Range            | 0.67A         | -    | 1.05A          |   |
| Current Accuracy                    | -5% $I_{set}$ | -    | +5% $I_{set}$  | $I_{set}>0.70A$   |
| Total Output Current Ripple (pk-pk) | -             | 5%   | 10%            | 20MHz BW, full load& LED load, the ripple would be tiny different under different LED load. |
| Startup Overshoot Current           | -             | -    | 10%            | 220~240Vac &100% Load, load is LED  |
| Line Regulation                     | -1%           | -    | +1%            | 25°C±10°C ambient temperature, input voltage changes from 200Vac to 240Vac.                 |
| Load Regulation                     | -5%           | -    | +5%            | 25°C±10°C ambient temperature, Input Voltage 230Vac, load changes from 60% to 100%.         |
| Turn-on Delay Time                  | -             | -    | 1.5s           | 230Vac, 100%Load  |
| Isolation input to output           | SELV          | -    | -              |   |
| Output Pst <sup>LM</sup>            | -             | -    | 0.03           | In entire operating window  |
| Output SVM                          | -             | -    | 0.03           | In entire operating window  |

## General Specifications

| Parameter   | Min   | Typ.                  | Max    | Notes  |
|---|---|-----------------------|--------|--|
| Efficiency@230Vac<br>I <sub>o</sub> =0.67A<br>I <sub>o</sub> =1.05A | 89%<br>87%                                  | 91%<br>89%            | -<br>- | Measured at full load and 25°C ambient temperature   |
| Mean Time Between Failure   | -   | 200Khours             | -      | 25°C±10°C ambient temperature, 230Vac, 80% load (MIL-HDBK-217F/SR-332)   |
| Life Time   | -   | 50Khours<br>100Khours | -      | T <sub>a</sub> =55°C, T <sub>c</sub> =85°C, 230Vac&100% Load<br>T <sub>a</sub> =45°C, T <sub>c</sub> =75°C, 230Vac&100% Load   |
| Operating Temperature T <sub>a</sub>                                | -40°C                                       | -                     | +55°C  | 230Vac&100% load; Humidity:10%RHto95%RH Non-condensing   |
| Operating T <sub>c</sub> for Safety T <sub>c_s</sub>                | -40°C                                       | -                     | +85°C  | Humidity:10%RHto95%RH Non-condensing   |
| Operating T <sub>c</sub> for Warranty T <sub>c_w</sub>              | -40°C                                       | -                     | +85°C  | 5 years warranty case temperature; Humidity:10%RHto95%RH Non-condensing  |
| Storage Temperature   | -40°C                                       | -                     | +85°C  |  |
| Altitude  | -60m  | -                     | 4000m  |  |
| Input Under voltage Protection                                      | 130Vac                                      | 150Vac                | 170Vac | When the input voltage is lower than the protection voltage, the driver will turn off automatically. When the input voltage exceeds the recovery voltage, the driver will restart automatically. |
| Input Over Voltage Protection                                       | 305Vac                                      | 325Vac                | 345Vac | The input voltage exceeds the protection voltage, the output is turned off. Automatic recovery. When the input voltage falls below the recovery voltage, the drive will restart.                 |
| Output Over Voltage Protection                                      | -   | -                     | -      | AC needs to be powered on again  |
| Over Temp Protection  | -   | 90°C                  | -      | T <sub>c</sub> ; 230Vac&100% load  |
| Short Circuit Protection  | -   | -                     | -      | self-recovery after 30 seconds   |
| Dimensions (L*W*H)mm  | 132.5*77*40mm                               |                       |        |  |
| Net Weight  | 220±50g/PCS                                 |                       |        |  |
| Package (L*W*H)mm   | 494*335*177mm; 30PCS/CTN, Gross Weight: 9kg |                       |        |  |

## DALI Specifications

| Parameter                     | Min                  | Typ. | Max                   | Notes                        |
|-------------------------------|----------------------|------|-----------------------|------------------------------|
| DALI-2 (High Voltage Level)   | 9.5V                 | 16V  | 22.5V                 |                              |
| DALI-2 (Lower Voltage Level)  | -6.5V                | 0V   | 6.5V                  | Return terminal is "DA-"     |
| DALI-2 (Dimming Output Range) | 10% I <sub>set</sub> | -    | 100% I <sub>set</sub> | I <sub>set</sub> =0.67~1.05A |
| DALI-2 (Sink Current)         | -                    | -    | 2.0mA                 |                              |

## Safety Specification

| Parameter                          | Min  | Typ.    | Max | Notes  |
|------------------------------------|------|---------|-----|--|
| Dielectric Strength(Input-Output)  | -    | 3750Vac | -   | 60s, Current not exceeding 5mA                           |
| Dielectric Strength(Input-Ground)  | -    | 3750Vac | -   | 60s, Current not exceeding 5mA                           |
| Dielectric Strength(Output-Ground) | -    | 500Vac  | -   | 60s, Current not exceeding 5mA                           |
| Insulation Resistance              | 10MΩ | -       | -   | Input-Output, Input-PE, Output-PE, 500Vdc/60s/25°C/70%RH |

## Safety Compliance

| Safety Category | Standards                        | Approved | Notes |
|-----------------|----------------------------------|----------|-------|
| CCC             | GB19510.1,GB19510.14             |          |       |
| CE              | EN61347-1, EN61347-2-13, EN62493 | √        |       |
| ENEC            | EN61347-1, EN61347-2-13, EN62384 | √        |       |
| CB              | IEC61347-1, IEC61347-2-13        | √        |       |
| BIS             | IS 15885(PART 2/SEC 13)          |          |       |
| UL              | UL 8750                          |          |       |
| CUL             | CSA C22.2 No.250.13              |          |       |
| KC              | K61347-1, K61347-2-13            |          |       |
| PSE             | J61347-1, J61347-2-13            |          |       |
| SAA             | AS/NZS IEC 61347.2.13            |          |       |
| SAA             | AS/NZS 61347.1                   |          |       |

## EMC Compliance

| EMC Category         | Standards                  | Approved | Notes |
|----------------------|----------------------------|----------|-------|
| CCC                  | GB/T 17743, GB 17625.1     |          |       |
| CE                   | EN 55015                   | √        |       |
| CE                   | EN 61000-3-2, EN 61000-3-3 | √        |       |
| CE                   | EN61000-4-2,3,4,5,6,11     | √        |       |
| CE                   | EN 61547                   | √        |       |
| KC                   | K61547                     |          |       |
| KC                   | K00015                     |          |       |
| PSE                  | J55015                     |          |       |
| FCC                  | FCC part 15                |          |       |
| Surge Shock Immunity |                            |          |       |
| Ringing Wave         |                            |          |       |

## RoHS

Our products comply with reference to RoHS Directive (EU) 2015/863 amending 2011/65/EU.

## Inrush Current

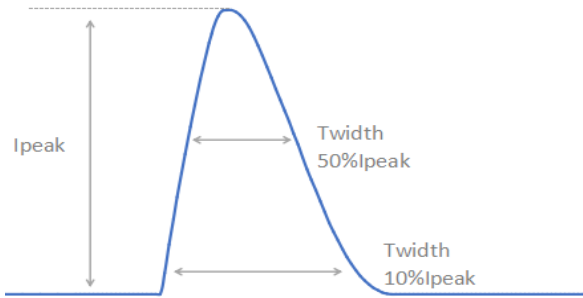

| $V_{in}$ | $I_{peak}$ | $T(@10\% \text{ of } I_{peak})$ | $T(@50\% \text{ of } I_{peak})$ |
|----------|------------|---------------------------------|---------------------------------|
| 230Vac   | 35A        | 430uS                           | 208uS                           |

**Output Voltage vs. Output Current**

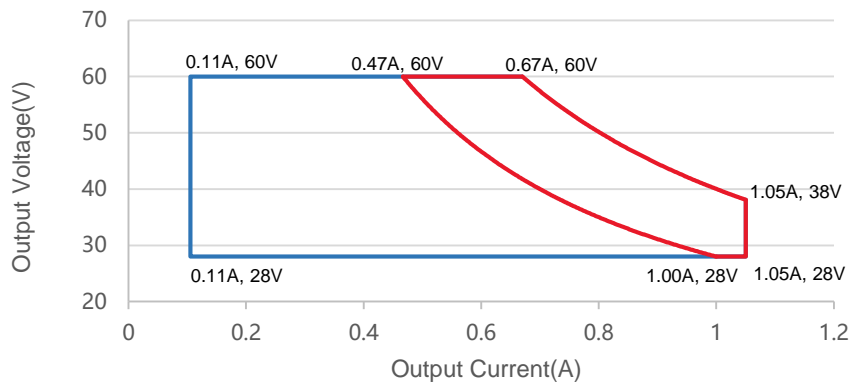

Red curve: good performance area

**Output Power vs. Input Voltage**

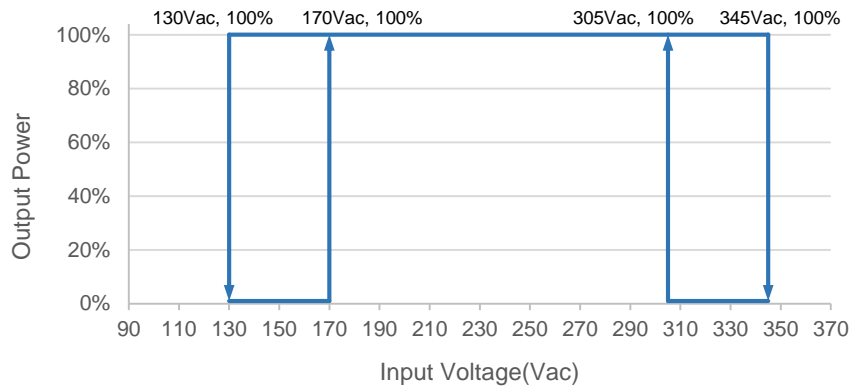

**Efficiency vs. load( $I_o=0.67A$ )**

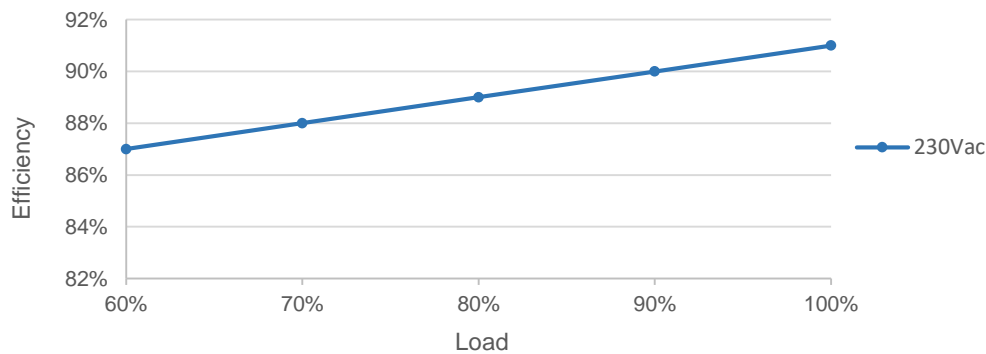

**Efficiency vs. Load ( $I_o=1.05A$ )**

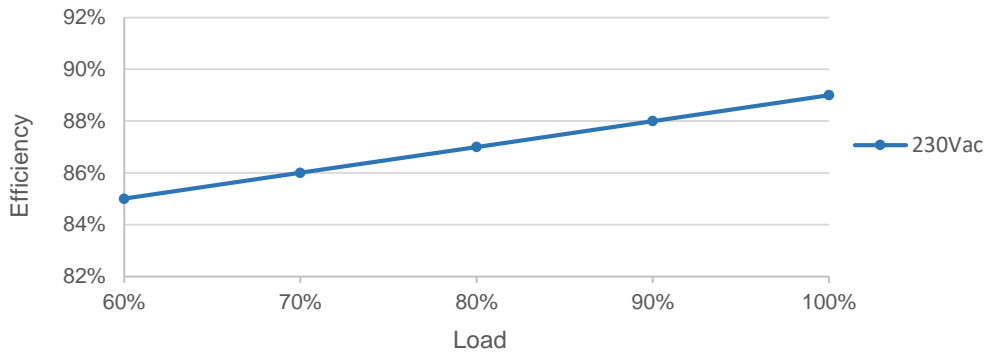

**PF vs. Load**

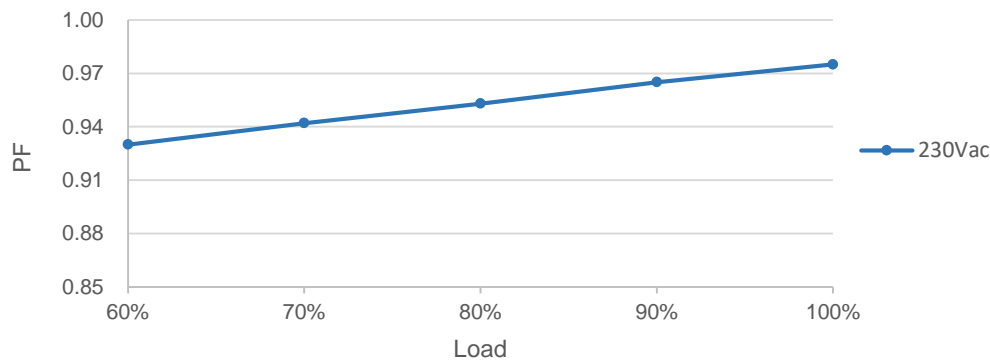

**THD vs. Load**

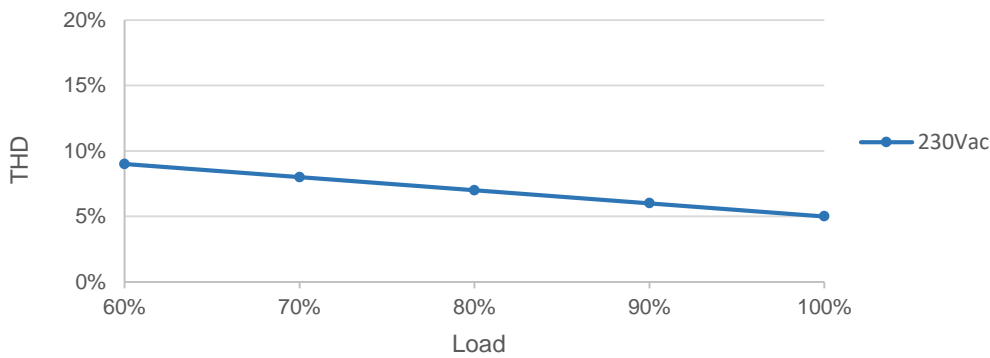

**Output Power vs. Ambient Temperature**

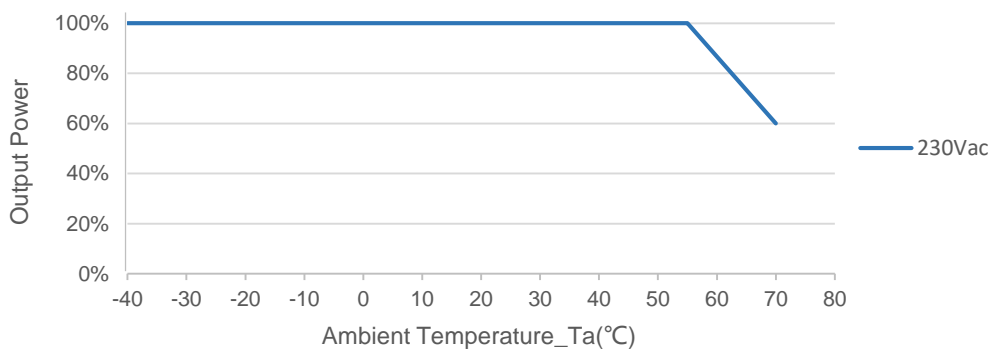

### Over Temperature Protection Curve

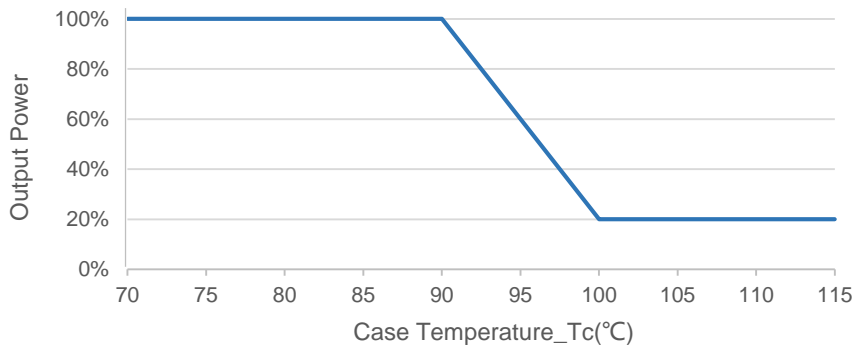

Notes: Customers can set the start derating temperature and end derating temperature. This curve is the default factory protection curve, When the temperature rises to the normal operating temperature, the drive will resume output.

### Lifetime vs. Case Temperature

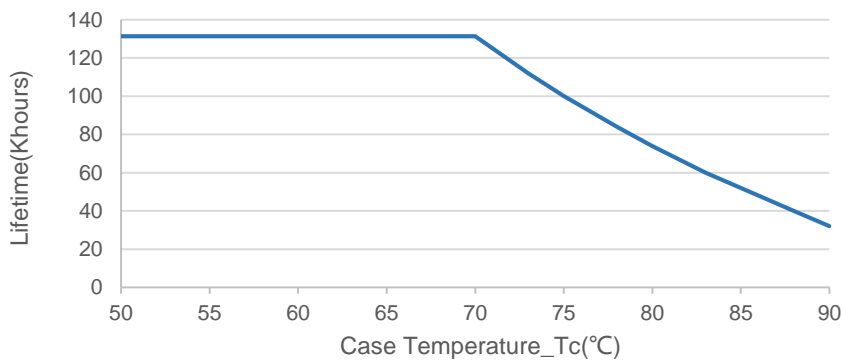

### DALI-2 Dimming

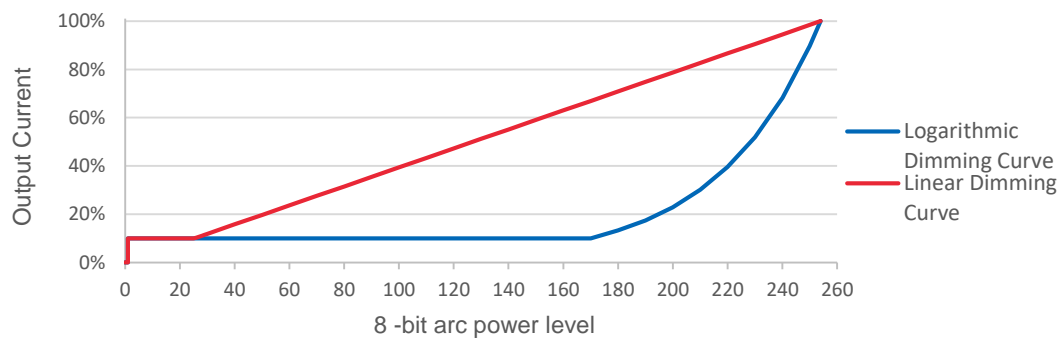

Note: Factory Default Output Logarithmic Curve

## Programming Link (DALI-2)

### Programming mode 1

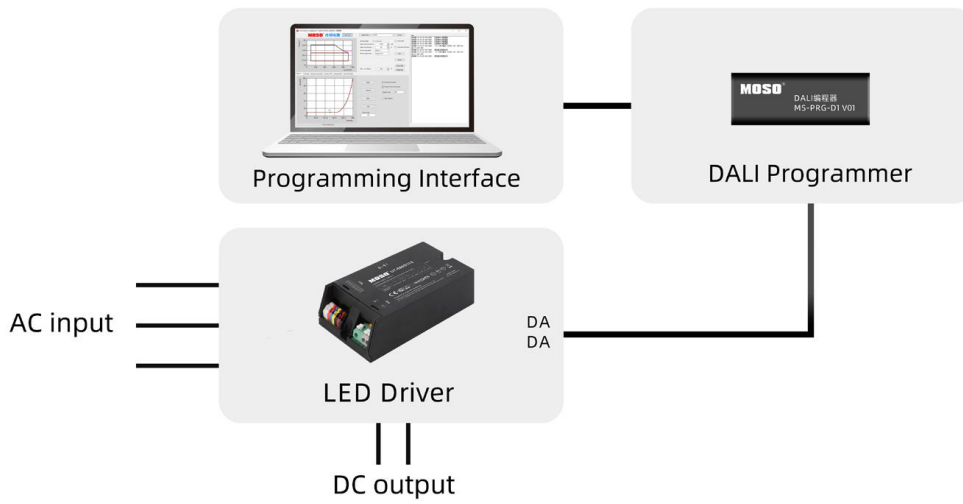

### Programming mode 2



#### Notes:

1. The driver does not need to be powered on during the programming process.
2. Please refer to MS-PRG-D1 or MS-PRG-N1 (Programmer) datasheet for details.
3. Applicable to FEIG programmer: ISC PRH101 and CPR30-USB



## Time Dimming

Time-controlled dimming is divided into three modes: Timing dimming, Virtual Midnight dimming, Self-Adaptive dimming.

### Timing Dimming

After the driver is powered on, the driver will change in sequence according to the programmed seven periods, and maintain the brightness of timer 7 after running to the last timer.

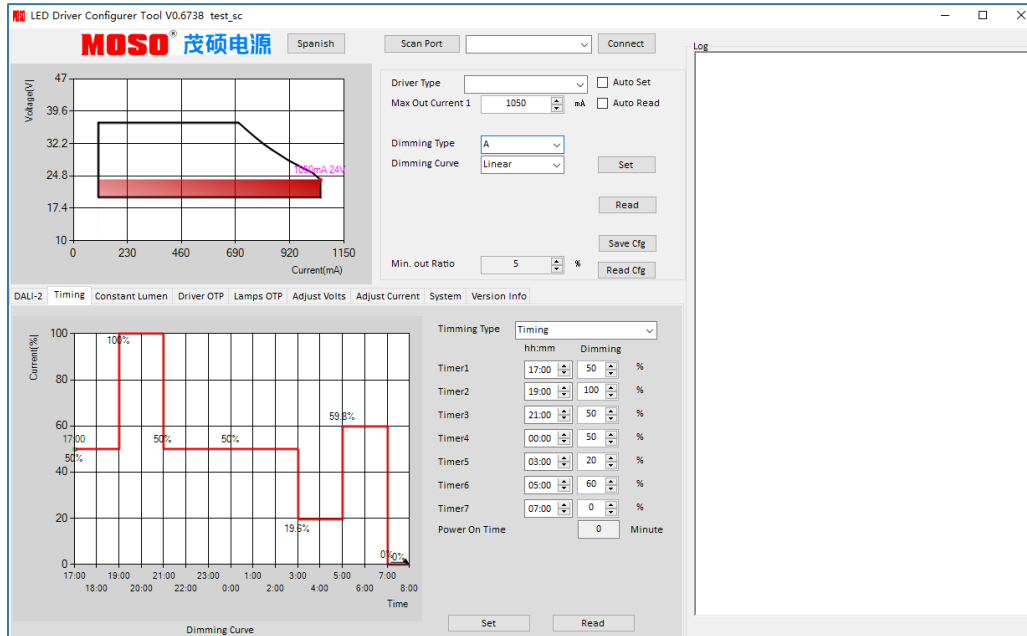

### Virtual Midnight Dimming

The power-on point and power-off point usually correspond to sunset time and sunrise time respectively, so their midpoint is the virtual midnight point. The driver will automatically sample the corresponding effective working days according to the reference days set by the customer, and automatically adjust the dimming curve according to the average working hours.

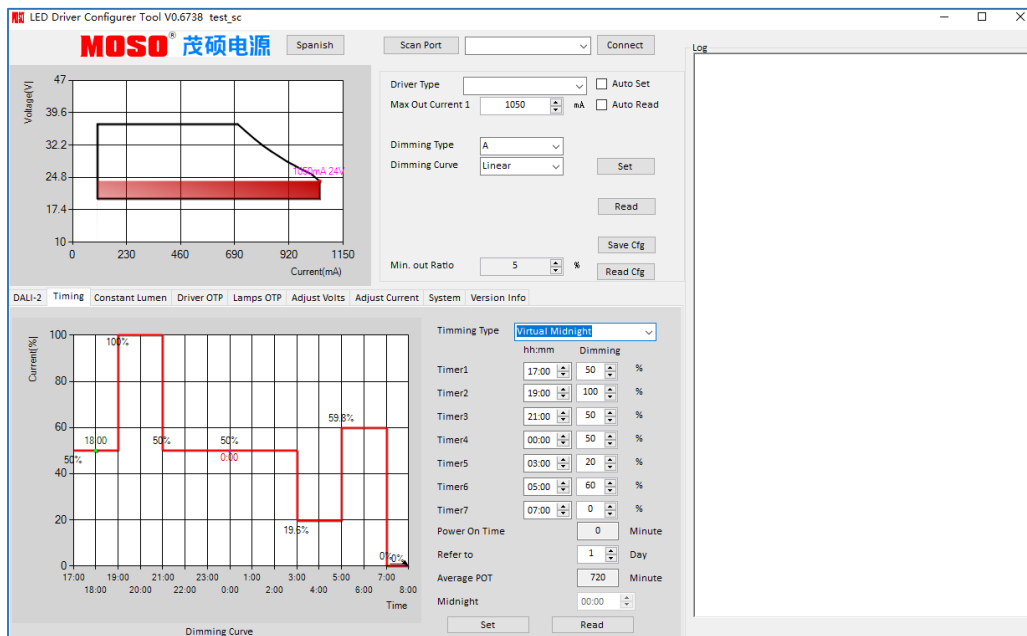

◆ Self - Adaption Dimming

Depending on the customer setup, the drive automatically calculates the effective mean operating time and calculates the ratio to the customer's set parameter time length, automatically making this computational ratio adjustment at each step.

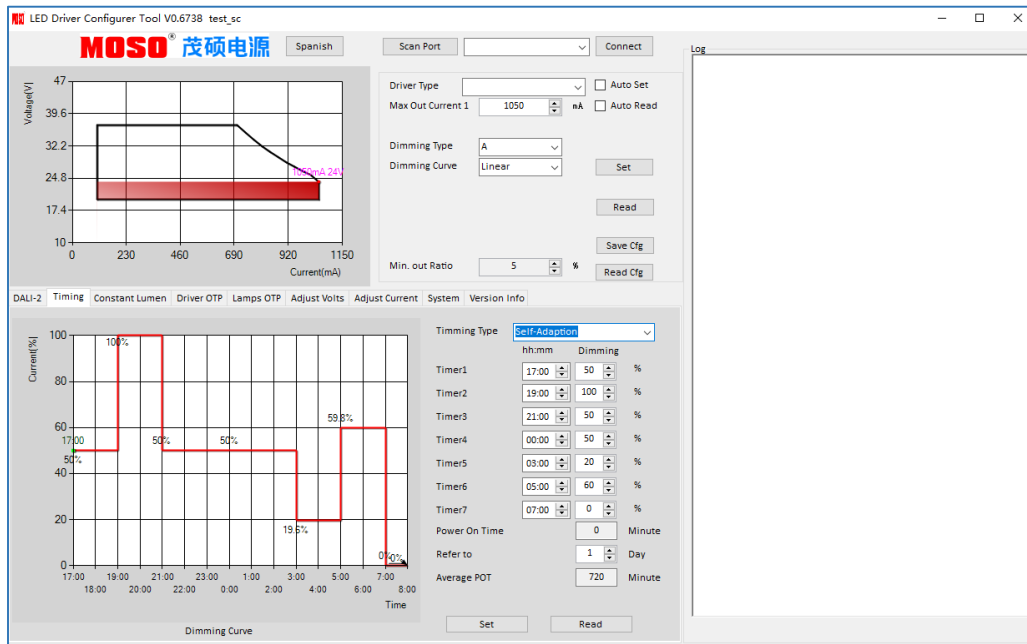

Note: Drives were judged only as valid working days if they were greater than 4 hours and less than 24 hours, and an effective on-off cycle was considered a day

CLO

CLO: With the increase of cumulative illumination time of LED light source, the LED driving can automatically increase its output current, and then realize the increasing of light flux output of LED light source with the increase of cumulative illumination time to achieve the purpose of light decay compensation. Thus the road surface illumination level is basically constant.

Note: Compensated current values are calculated as a percentage based on IMAX. The minute setting column is only used by the customer to test the CLO function. The driver will reset the hour setting column after power failure and power on again. The "ENABLE check box" must be checked to enable the CLO function

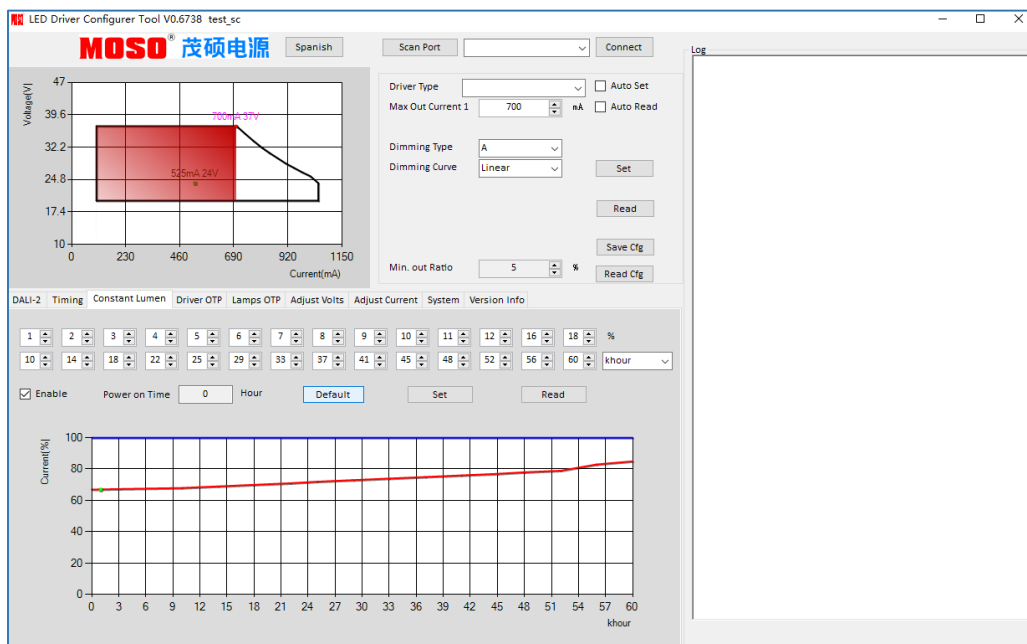

**Mechanical Outline**

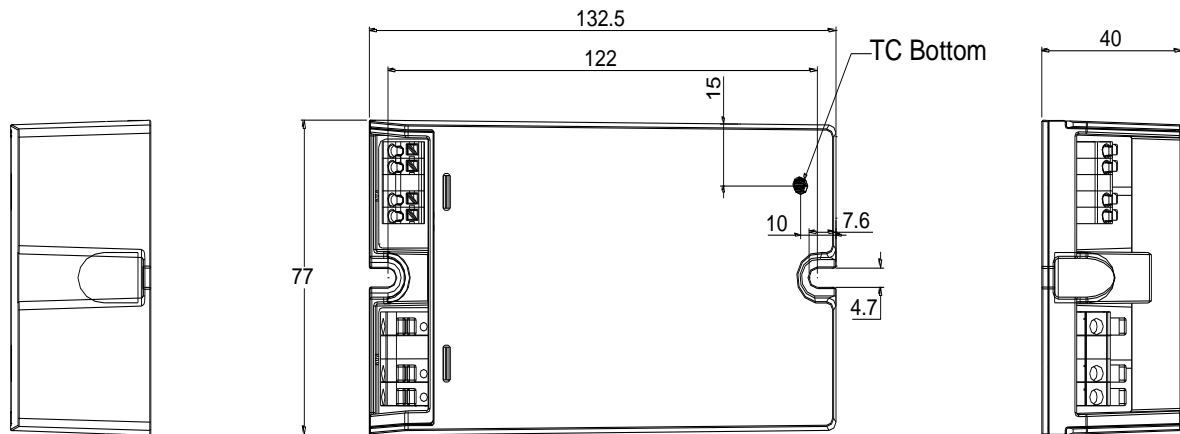

**Notes:** EQUI pin connects to ground wire and metal housing of luminaires for Class I applications, and to metal housing for Class II applications.

**Connections**

|                      |   |   |
|----------------------|---|---|
| <b>Input (L,N,G)</b> | Wire Cross-section 0.5 mm <sup>2</sup> - 1.5 mm <sup>2</sup> /20 AWG - 16 AWG | Push-in at 45° angle, solid and stranded wire |
| <b>Output</b>        | Wire Cross-section 0.2 mm <sup>2</sup> - 1.5 mm <sup>2</sup> /22 AWG - 16 AWG | Push-in at 45° angle, solid and stranded wire |
| <b>Dimming</b>       | Wire Cross-section 0.2 mm <sup>2</sup> - 0.5 mm <sup>2</sup> /22 AWG - 20 AWG | Push-in at 45° angle, solid and stranded wire |

**Label**

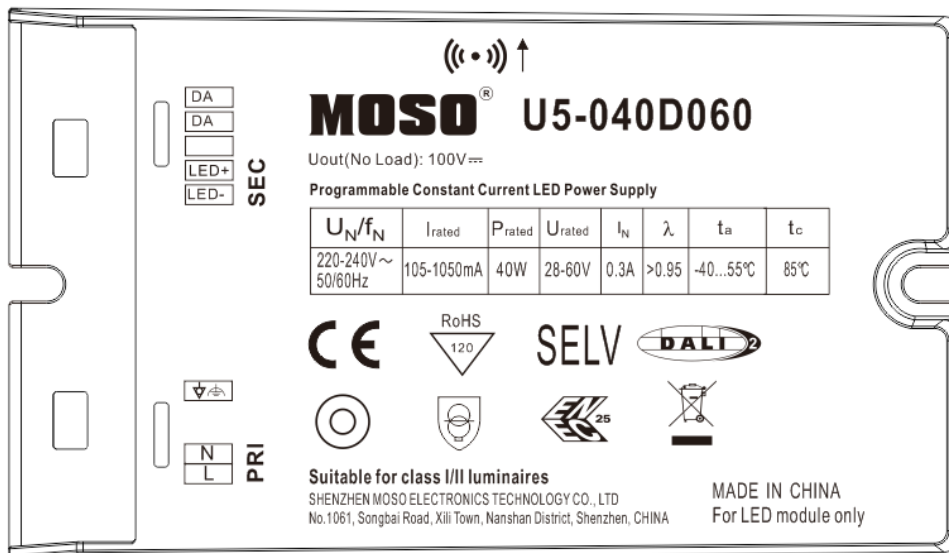

For shell label (27\*9mm)

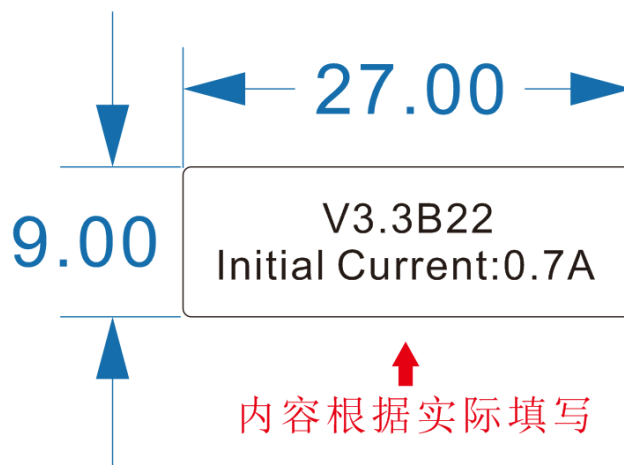

For carton label(100\*60mm)

|                  |                        |            |            |
|------------------|------------------------|------------|------------|
| P/O No:          | 1234567890<br>         | Q'ty:      | 20 PCS<br> |
| Model:           | 9876543210             | N.W.:      | 26.50 KG   |
| Item No:         | MSL-TO350IC102.0-100Y2 | G.W.:      | 26.50 KG   |
| Customer No:     | 13577                  | Date Code: | 2019-09-27 |
| Initial Current: | 5A                     |            |            |
| CTN No:          | 91234567890001<br>     |            |            |

打印客户提供型号

在MOSO标准上更改客户型号，未注明按实际出货打印

**Version**

|     |               |            |
|-----|---------------|------------|
| A.1 | First release | 2024.10.23 |
|     |               |            |
|     |               |            |
|     |               |            |
|     |               |            |
|     |               |            |

# Specification for Approval

Product Name: 40W Class I/II LED Driver

Product Model: U5-040D060

Rev : A.1

Address: XiLi Songbai Road 1061, Nanshan District, Shenzhen City, Guangdong, China

Tel: 0755-27657000

FAX: 755-27657908

E-mail: info@mosopower.com

Web Site: <http://www.mosopower.com>

| Prepared By | Checked By | Approved By |
|-------------|------------|-------------|
|             |            |             |

## Specification for Approval

Product Name: 40W Class I/II LED Driver

Product Model: U5-040D060

Rev: A.1

| CUSTOMER AUTHORIZED SIGNATURE   |            |             |
|---|------------|-------------|
| Tested By   | Checked By | Approved By |
|   |            |             |
| (Company seal)Return one copy to MOSO with approved signature and company seal. |            |             |

Address: XiLi Songbai Road 1061, Nanshan District, Shenzhen City, Guangdong, China

Tel: 0755-27657000

FAX: 755-27657908

E-mail:info@mosopower.com

Web Site: <http://www.mosopower.com>

| Prepared By | Checked By | Approved By |
|-------------|------------|-------------|
|             |            |             |