



Product Features

- Universal input voltage / Full range: 90~305Vac;
- Constant power design, output current programming adjustable;
- (M types) off-line programmable, (V types) output current adjustable by built-in potentiometer;
- 3-in-1 dimmable: 0~10Vdc, PWM, Positive and negative logic, Timer dimming, Dim-to-off;
- (M types) Constant lumen output ,daily log;
- Output and Dimming Signal Isolating;
- Surge protection: 6KV line-line, 10KV line-earth
- Protections: SCP / OVP / OTP;
- IP67 design for indoor and outdoor applications;
- Suitable for dry / damp / wet locations;
- 5 years warranty.

Application

- Suitable for LED roadway lighting, industrial lighting, landscape lighting, etc.

DESCRIPTION

The X6-105W series is a 105W outdoor off-line programmable LED driver that operates in constant current with high PF value and universal input voltage range of 90~305Vac. Monitored off-line by dimming cable connected with an USB kit programming device, the fully programmed drivers offer all dimming, dim-to-off, constant lumen output options and a wide range of output current in a single driver, providing maximum flexibility with customized operating settings and intelligent control options for lighting manufacturers, as one driver can be programmed for many different luminaire designs. X6 provides built-in timer dimming schedules that further increase the energy savings and CO₂ reductions achieved with LED lighting. It also helps customers to improve logistics and inventory management. The compact metal case and high efficiency enables the driver to operate with high reliability and extend product life. Overall protection is provided against lightning surge, output over voltage, short circuit, and over temperature, to ensure low failure rate.

MODELS

Model Number [1]	Max Output Power (W)	Output Voltage Range (Vdc)	Full Power Output Voltage Range(Vdc)	Full Power Current Adjustable Range (A) [2]	Default Output Current Setting(A)	Typical Efficiency [3]	Power Factor
X6-105Y100	105	50-100	75-100	1.05-1.40	1.40	91%	0.97

Notes:

[1]. Y can be M or V, Y=M means dimmable and off-line programmable. The adjustable lout range: 10%-100% I_{max}, Y=V means non-dimmable and output current adjusted by built-in potentiometer.

[2]. Output current adjustable range with constant power at max output power;

[3]. All specifications are measured at 25°C ambient temperature, input voltage 230Vac, and the typical value tested by full load, if no specific note.

OPERATING AREA I-V

X6-105Y100

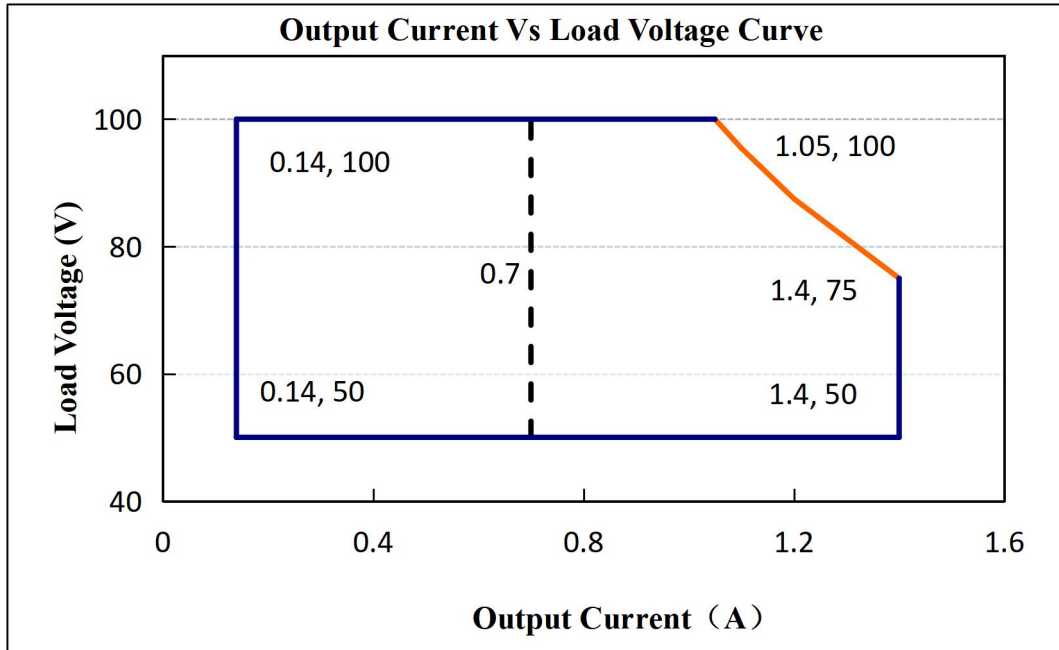

Notes: The drivers are not allowed to work in over-load condition, otherwise warranty will expire. Y=V is suitable for the right area of the dotted line; Y=M is suitable for the solid line contain area.

INPUT SPECIFICATIONS

Parameter	Min.	Typ.	Max.	Notes			
Input Voltage	90Vac	100-277Vac	305Vac				
Input Frequency	47Hz	50/60	63Hz				
Leakage Current	-	-	0.70mA	277Vac/60Hz			
Input AC Current	-	-	1.5A	100-277Vac & full load			
Inrush Current	-	-	75A	230Vac & full load			
Standby Power Consumption			2W				
Power Factor	0.97	0.99	-	120Vac, 50-60Hz, full load			
	0.95	0.97		230Vac, 50-60Hz, full load			
	0.92	0.95		277Vac, 50-60Hz, full load			
THD	-	5%	10%	100-240Vac, 50-60Hz, 50%-100% load			
	-	-	15%	277Vac, 50-60Hz, 70%-100% load			
Max. NO. of PSUs on CIRCUIT BREAKER	B10	3	B16	4	B25	7	230Vac
	C10	5	C16	7	C25	11	

OUTPUT SPECIFICATIONS

Parameter	Min.	Typ.	Max.	Notes
Output Current Tolerance	-5%	-	5%	
Output Current Setting Range (A) X6-105Y100	0.70	-	1.40	The 'M type' adjustable lout range: 10%-100% I _{max} ,
Output Current Setting Range with Constant Power X6-105Y100	1.05	-	1.40	
Total Output Current Ripple(pk-pk)	-	5%	10%	20MHz BW, full load& LED load, the ripple would be tiny different under different LED load.
Startup Overshoot Current	-	-	10%	100~277Vac &100% Load, load is LED
No Load Output Voltage X6-105Y100	-	-	120	
Line Regulation	-1%	-	1%	25°C±10°C ambient temperature, input voltage changes from 100Vac to277Vac.
Load Regulation	-3%	-	3%	25°C±10°Cambient temperature, Input Voltage 230Vac, load changes from 60% to 100%.
Turn-on Delay Time	-	1S	2S	120Vac,100% load
	-	-	0.5S	230Vac,100% load

GENERAL SPECIFICATIONS

Parameter	Min.	Typ.	Max.	Notes
Efficiency @120Vac X6-105Y100 I _o =1.05 I _o =1.40	87% 86%	89% 88%		Measured at full load and 25°C ambient temperature
Efficiency @230Vac X6-105Y100 I _o =1.05 I _o =1.40	89% 88%	91% 90%	-	Measured at full load and 25°C ambient temperature
Efficiency @277Vac X6-105Y100 I _o =1.05 I _o =1.40	89% 88%	91% 90%		Measured at full load and 25°C ambient temperature
Dielectric Strength	Input-Output	-	3750Vac	-
	Input-PE	-	1600Vac	-
	Output-PE	-	1600Vac	-
Grounding Resistance	-	-	0.1Ω	25A/60S, under 25°C±10°C ambient temperature
Insulation Resistance	10MΩ	-	-	Input-Output, Input-PE, Output-PE, 500Vdc/60S/25°C/70%RH
MTBF	-	200000Hrs	-	25°C±10°C ambient temperature, 230Vac,80% load (MIL-HDBK-217F)
Lifetime	-	50000Hrs	-	230Vac&100% load, 75°C case temperature, refer to lifetime curve for details

Ambient Temperature	-40℃		+60℃	Reference derating curve
Operating Case Temperature for Safety Tc_s	-40℃	-	+90℃	
Operating Case Temperature for Warranty Tc_s	-40℃	-	+75℃	5 years warranty case temperature Humidity: 10% to 95% RH
Storage Temperature	-40℃	-	+85℃	Humidity: 5% to 100% RH
Dimensions (LxWxH)mm	L153.6*W68*H37			
Net Weight	700±100g/PCS			
Package	L488mm*W298mm*H200mm; 15PCS/Ctn, Gross Weight:12.2Kg			

DIMMING

Parameter		Min.	Typ.	Max.	Notes
0~10V Absolute Maximum Voltage on the Vdim (+) Pin		-	10V	-	
0~10V Source Current on Vdim(+)Pin		-	200uA	400uA	
Dimming Output Range	X6-105M100	10%Imax	-	100%Imax	Imax=1.40A
	X6-105M100	0.14	-	1.40	
Recommended Dimming Range for 0-10V		0V	-	10V	Default 0-10V/ PWM Dimming(0-10V,0-9V,0-5V,0-3.3V Positive and Reverse Logic can be customized as request)
PWM_in High Level		9.7V	-	10.3V	
PWM_in Low Level		0V	-	0.3V	
PWM_in Frequency Range		300Hz	-	2000Hz	
PWM_in Duty Cycle		1%	-	99%	

SAFETY STANDARDS

Safety Category	Country / Territory	Standards	Approved
CCC	China	GB19510.1, GB19510.14	√
CE	Europe	EN61347-1, EN61347-2-13	√
		EN62493	√
		EN62384	√
CB	CB Countries	IEC61347-1, IEC61347-2-13	√
BIS	India	IS 15885(PART 2/SEC 13)	
UL	USA	UL 8750	√
CUL	Canada	CSA C22.2 No.250.13	√
KC	South Korea	K61347-1, K61347-2-13	
PSE	Japan	J61347-1, J61347-2-13	
SAA	Australia	AS/NZS IEC 61347.2.13	√
		AS/NZS 61347.1	√
EAC	Russia	ГОСТ Р МЭК 61347-1-2011 ГОСТ IEC 61347-2-13-2013 ГОСТ IEC 62493-2014 СТБ EH 55015-2006 ГОСТ IEC 61547-2013 ГОСТ 30804.3.2-2013 (IEC 61000-3-2:2009) ГОСТ 30804.3.3-2013 (IEC 61000-3-3:2008)	√

Insulation

Insulation	Input/Mains	DIMING	LED Output	Case
Input/Mains	/	Double	Double	Basic
DIMING	Double	/	Basic	Basic
LED Output	Double	Basic	/	Basic
Case	Basic	Basic	Basic	/

EMC COMPLIANCE

EMC Category	Country / Territory	Standards	Approved
CCC	China	GB/T 17743, GB 17625.1	√
CE	Europe	EN 55015	√
		EN 61000-3-2, EN 61000-3-3	√
		EN61000-4-2,3,4,5,6,11	√
		EN 61547	√
KC	South Korea	K61547	
		K00015	
PSE	Japan	J55015	
FCC	USA	FCC part 15	√

NOTE:

This LED driver meets the EMI specifications above, but as a component of a luminaire, the end customer need to identify the EMI performance of a luminaire including the LED driver, other devices connected to the driver, and on the luminaire itself.

INRUSH CURRENT WAVEFORM

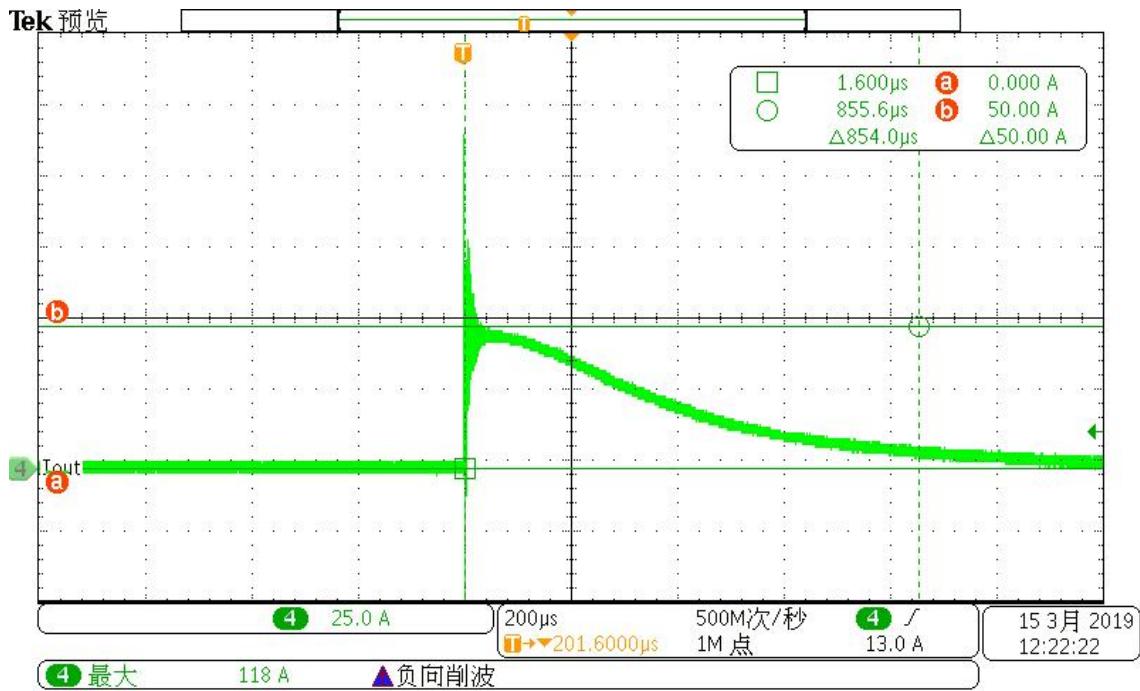

DERATING CURVE

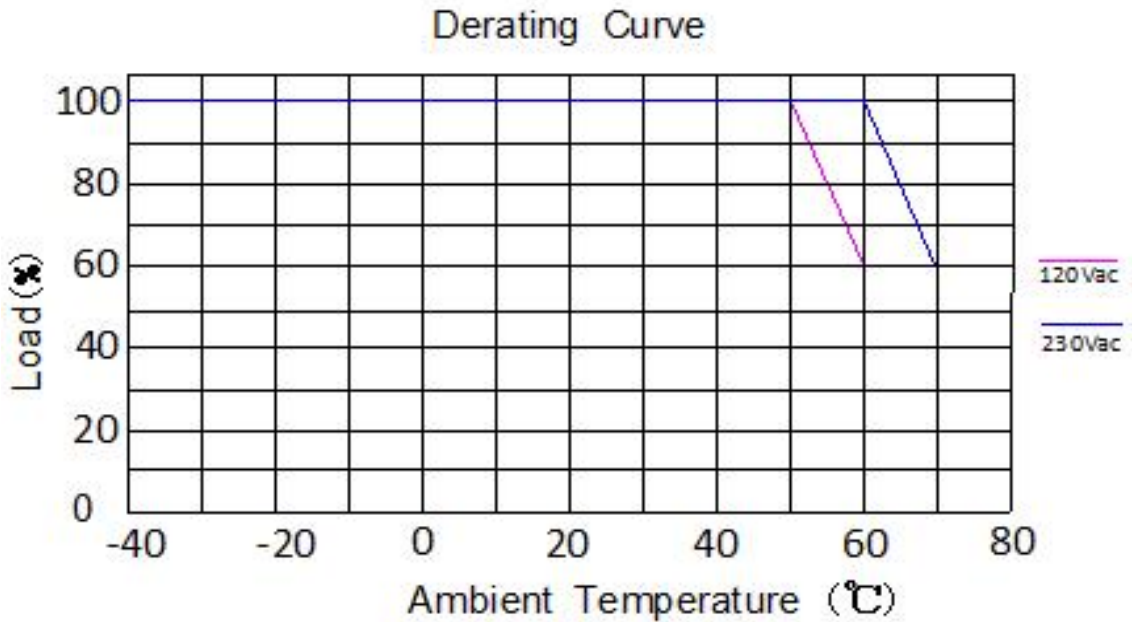

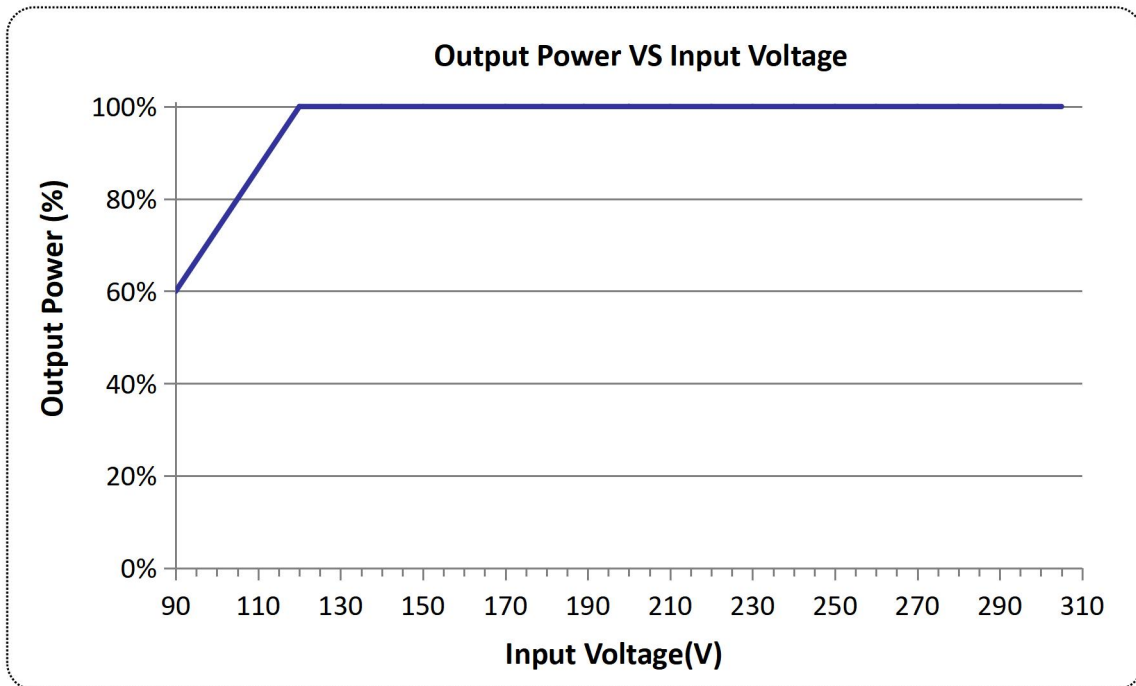
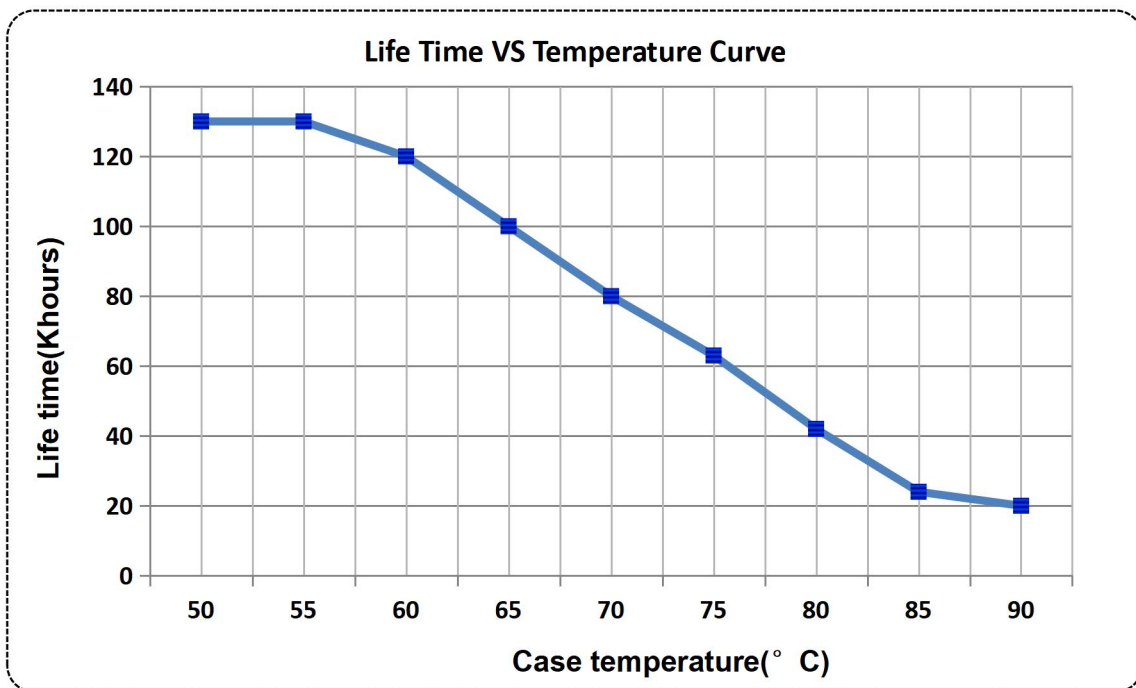
OUTPUT POWER VS INPUT VOLTAGE**LIFETIME VS CASE TEMPERATURE**

EFFICIENCY VS LOAD

X6-105Y100 (I_o=1.05A)

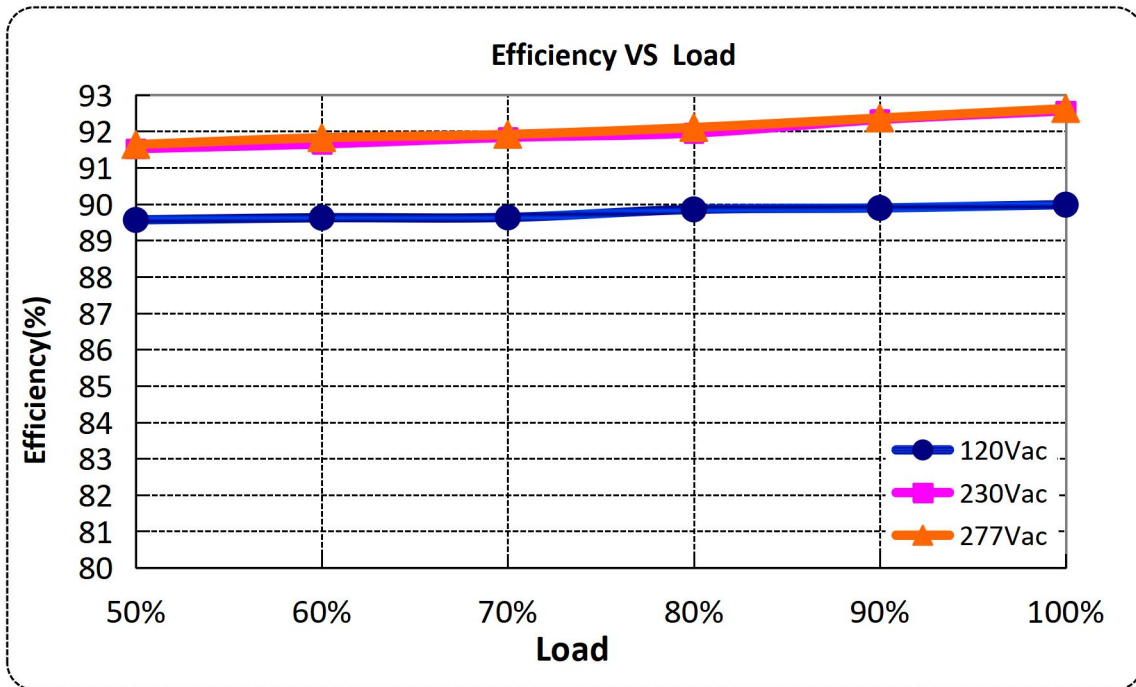

X6-105Y100 (I_o=1.40A)

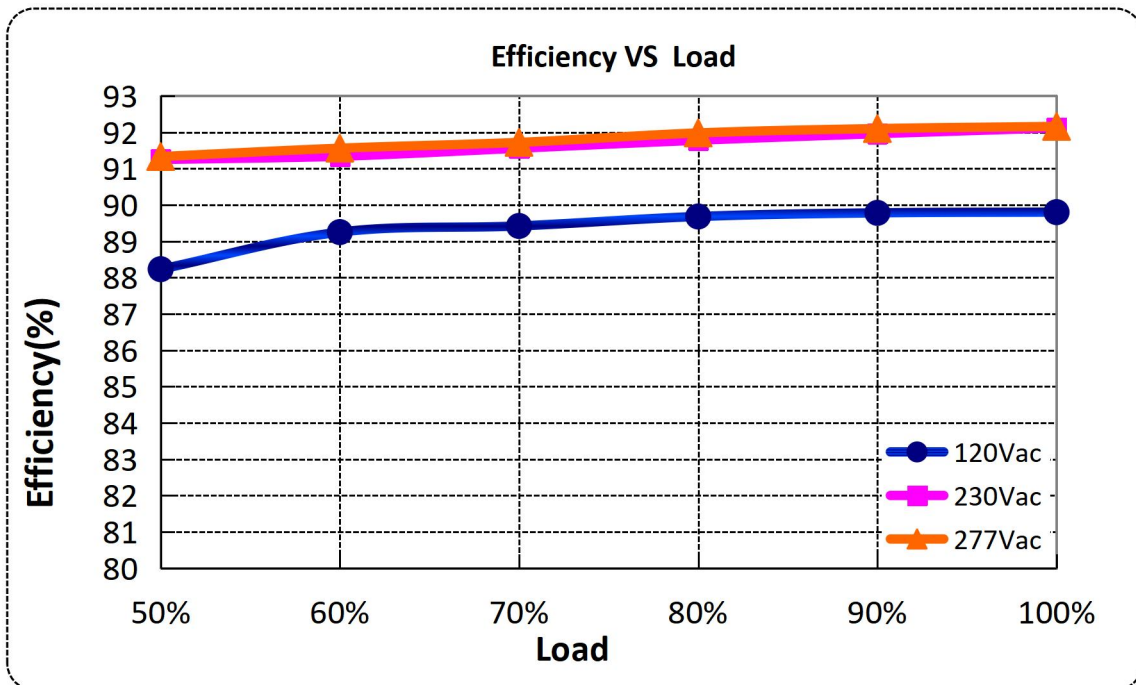

POWER FACTOR VS LOAD

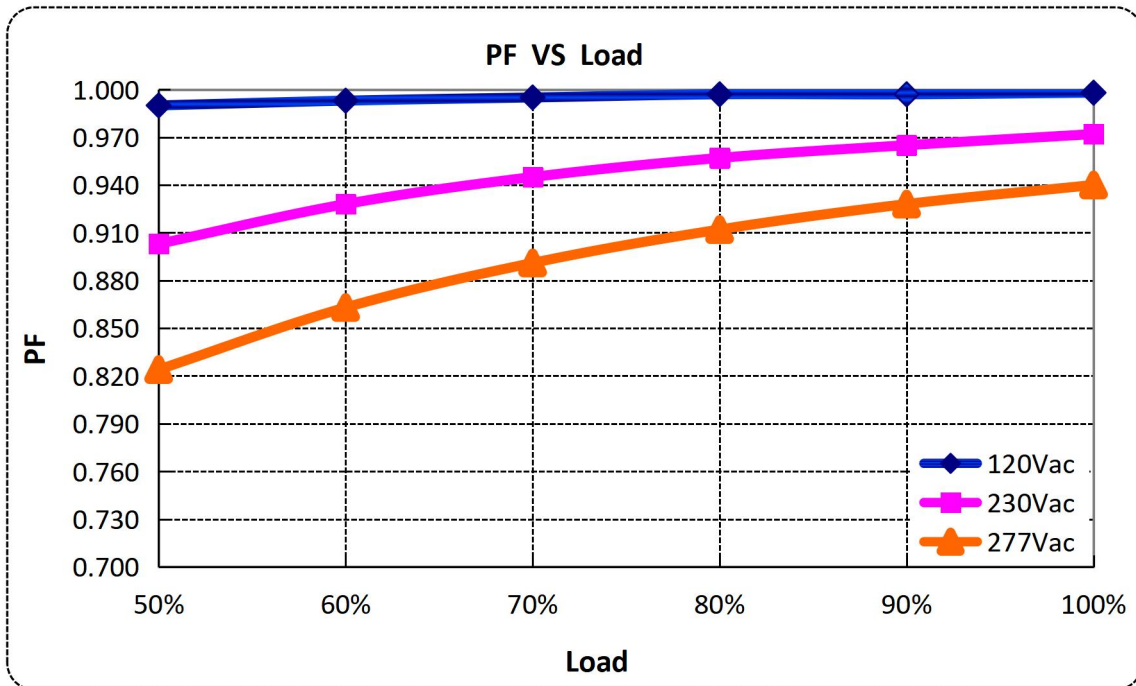

TOTAL HARMONIC DISTORTION

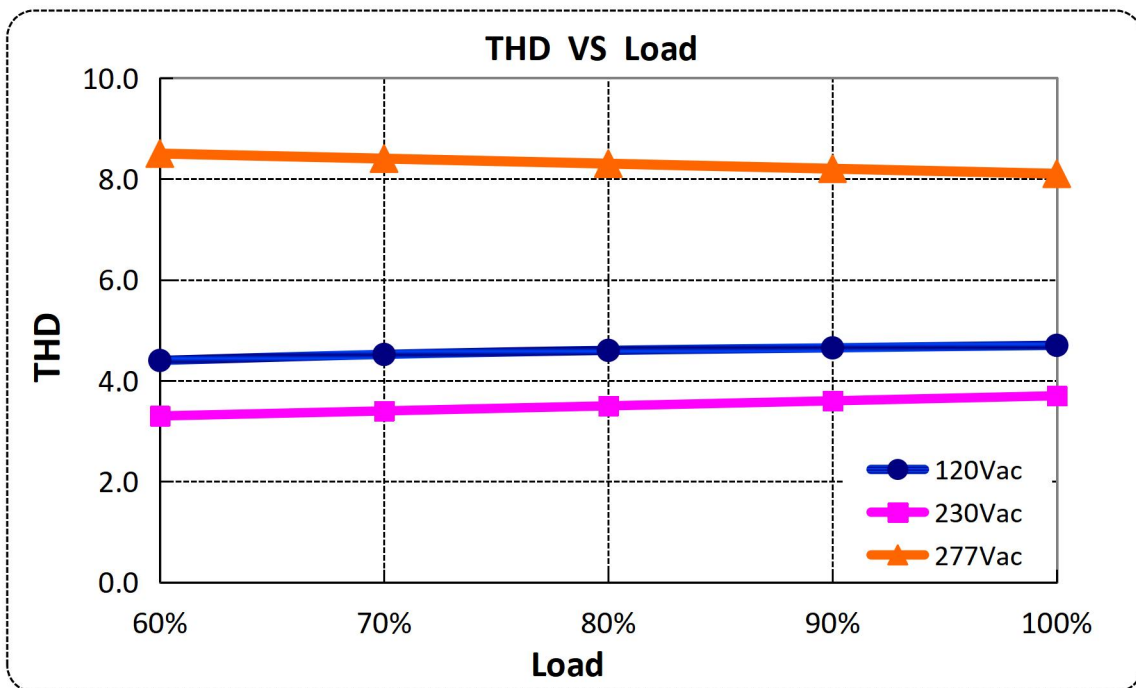

PROTECTIONS

Parameter	Notes
Over Temperature Protection	Decreases output current, returning to normal after over temperature is removed. The max derating could be met Max Temperature 85°C and Max Humidity 85%.
Short Circuit Protection	Hiccup mode and auto recovery. No damage will occur when any output is short-circuited. The output shall return to normal when the fault condition is removed.
Over Voltage Protection	Run into protection mode when output voltage exceeds limit, and return to normal when the fault is eliminated and restart the power supply.

0-10V/PWM DIMMING

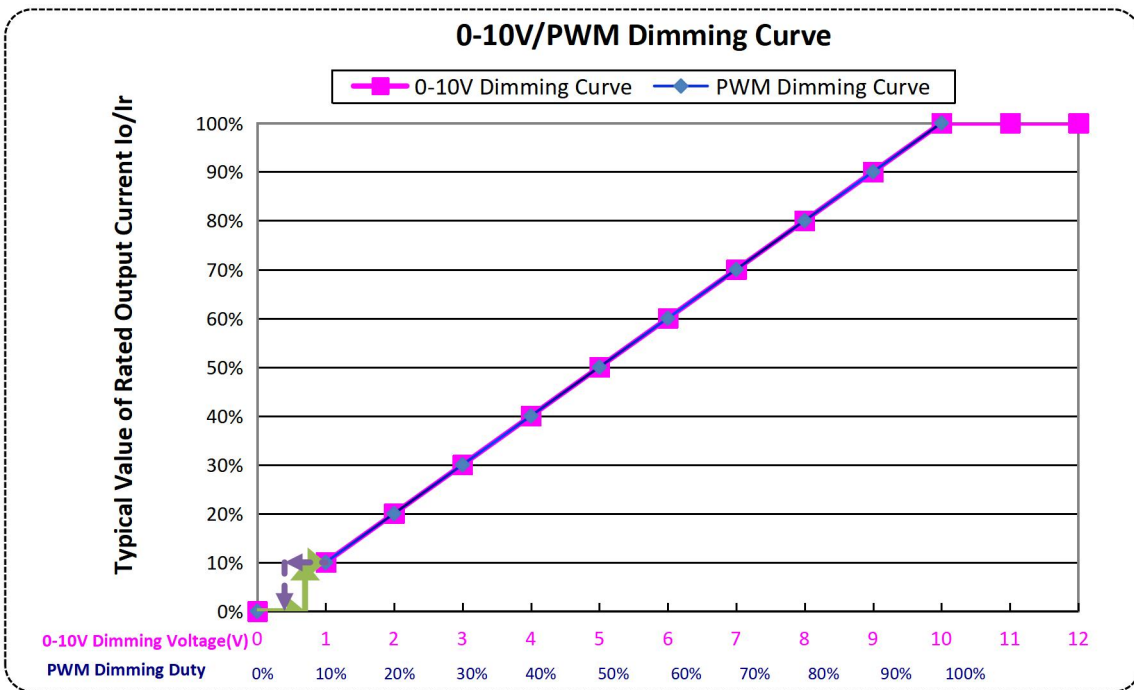

Note:

The dim to off model is realized by decreasing the output voltage, the power supply still has a residual voltage when dim to off, so the start up voltage of the lamp should be higher than residual voltage.

MECHANICAL OUTLINE

X6-105M100

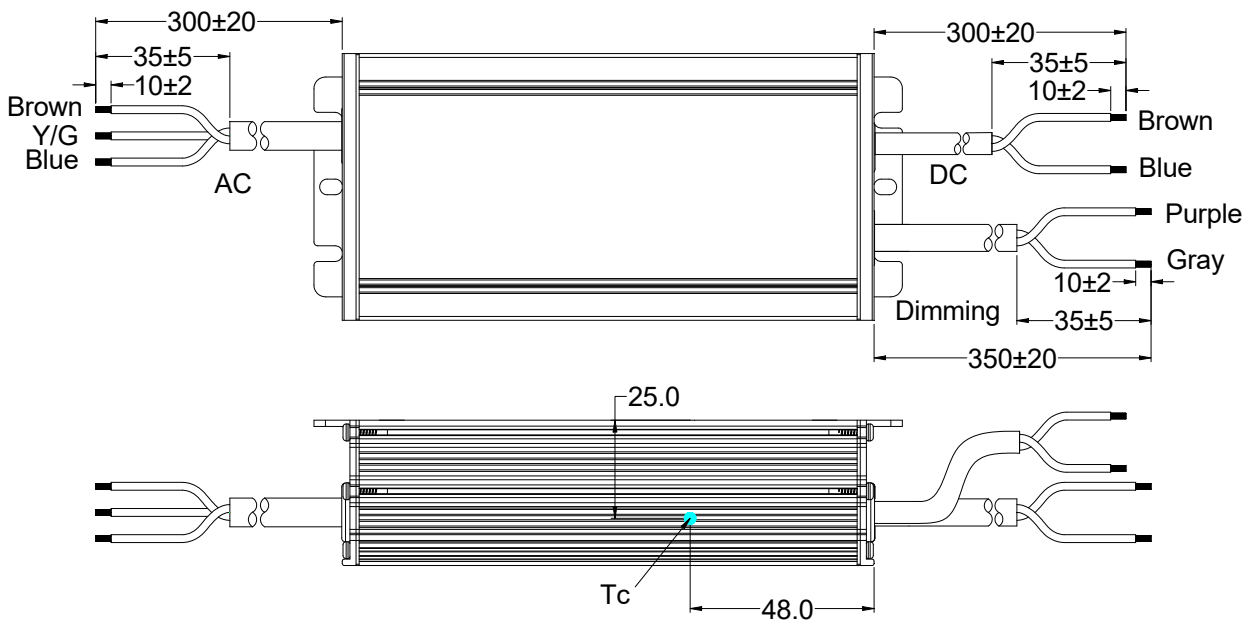
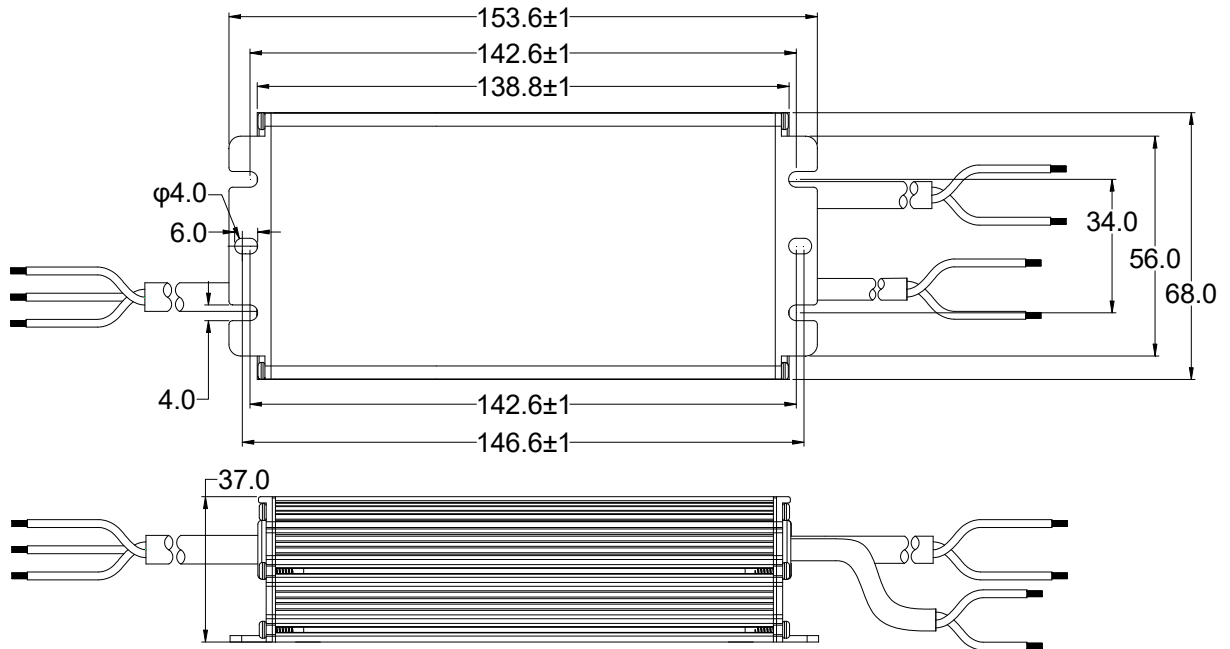

X6-105V100

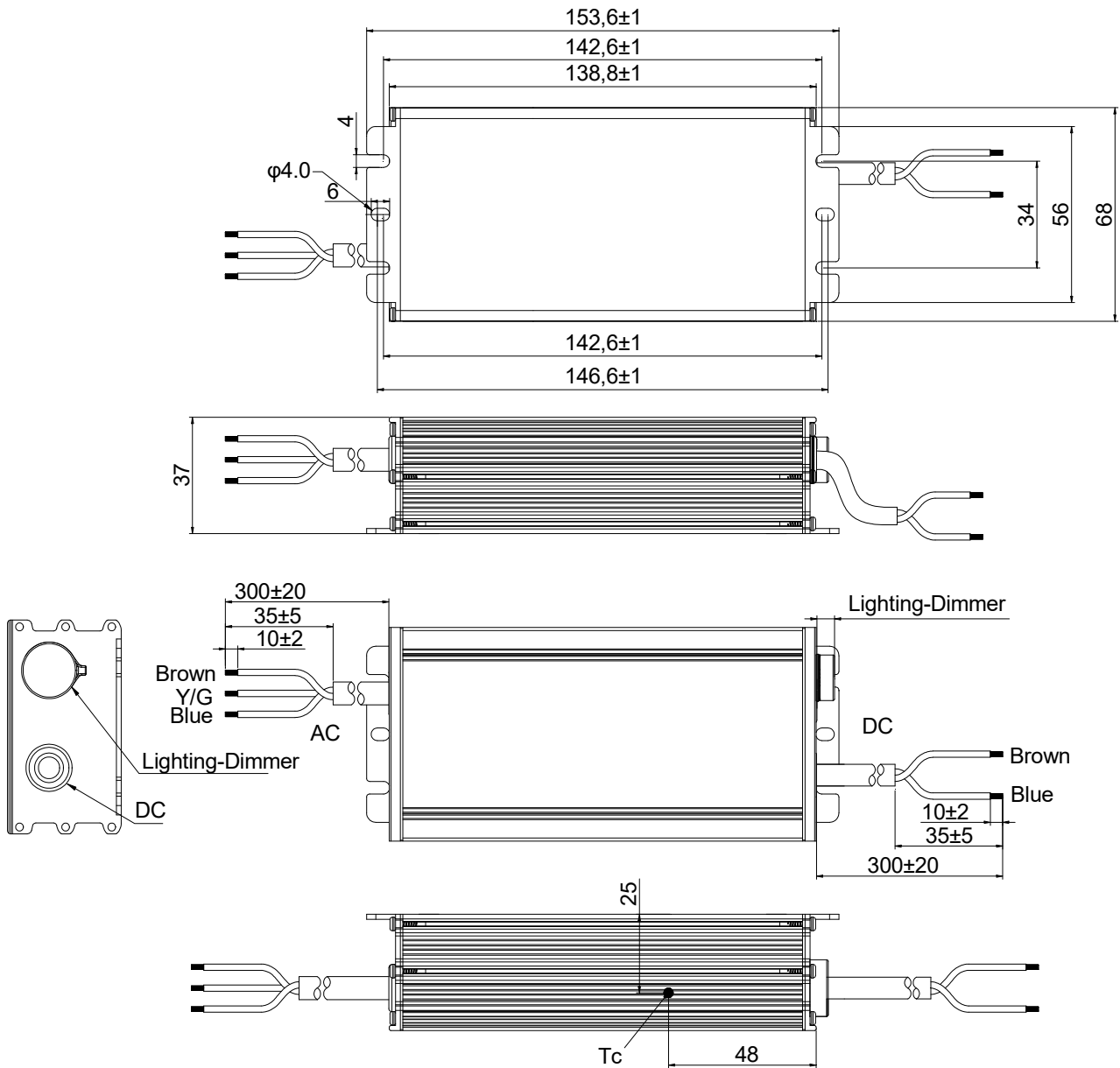

Wire	Specification	Note
Input	SJOW 17AWG*3C external diameter: 8.2mm L=300±20mm,	CCC/CE/UL
Output	SJOW 17AWG*2C external diameter: 7.7mm L=300±20mm	CCC/CE/UL
Dimming	UL2733 22AWG*2C external diameter: 5.45mm L=350±20mm,	Y = M

LABEL

X6-105M100

129.00 mm

45.50 mm

INPUT

L (BROWN 棕)

G (Y/G 黄/绿)



N (BLUE 蓝)

MOSO[®] X6-105M100

LED DRIVER
LED 控制装置(恒流型)

INPUT (输入)	100-240V~50/60Hz, 1.5A Max. PF:0.95 277V~ 50/60Hz, 0.5A Max (277V~ for North America only)
OUTPUT (输出)	50-100V= 0.14-1.40A Max.(最大电压): 120V= Max.Power(最大功率):105W
t _c : 90°C	t _a : 50°C Input:100-200V~ t _a : 60°C Input:200-240V~,277V~

MADE IN CHINA
For LED module only

Suitable for Dry, Damp and Wet locations
SHENZHEN MOSO ELECTRONICS TECHNOLOGY CO., LTD
No.1061, Songbai Road, Xili Town, Nanshan District,
Shenzhen, CHINA









OUTPUT



(BROWN 棕) Vo +

(BLUE 蓝) Vo -

(PURPLE 紫) DIM +

(GRAY 灰) DIM -

X6-105V100

129.00 mm

45.50 mm

INPUT

L (BROWN 棕)

G (Y/G 黄/绿)



N (BLUE 蓝)

MOSO[®] X6-105V100

LED DRIVER
LED 控制装置(恒流型)

INPUT (输入)	100-240V~50/60Hz, 1.5A Max. PF:0.95 277V~ 50/60Hz, 0.5A Max (277V~ for North America only)
OUTPUT (输出)	50-100V= 0.70-1.40A Max.(最大电压): 120V= Max.Power(最大功率):105W
t _c : 90°C	t _a : 50°C Input:100-200V~ t _a : 60°C Input:200-240V~,277V~

MADE IN CHINA
For LED module only









Suitable for Dry, Damp and Wet locations
SHENZHEN MOSO ELECTRONICS TECHNOLOGY CO., LTD
No.1061, Songbai Road, Xili Town, Nanshan District,
Shenzhen, CHINA



OUTPUT

Io ADJ ⊕

(BROWN 棕) Vo +

(BLUE 蓝) Vo -

Page 13 / 13

Specification subject to change without notice

www.mosopower.com

Tel:+86-755-27657000

Email: info@mosopower.com

Form No.:FP-10-017RevA/1.0



REVISION HISTORY

Version	Description of Change		Date	Notes
	Before	Now		
A.1	—	Datasheets Release	2023-03-24	
B.2		ECL202310029	2023-10-25	

Specification subject to change without notice

Specification for Approval

Product Name: 105W off-line programmable driver
Product Model: X6-105M100
X6-105V100
Rev. B.2
Sample Date: -

CUSTOMER AUTHORIZED SIGNATURE		
Tested By	Checked By	Approved By
(Company seal)Return one copy to MOSO with approved signature and company seal.		

XiLi Songbai Road 1061, Nanshan
Address: District, Shenzhen City, Guangdong Province, P.R.China Post Code: 518108
TEL: 0755-27657000 FAX: 0755-27657908
E-mail: info@mosopower.com Web site: http://www.mosopower.com

Prepared By	Checked By	Approved By

Product Specification

Product Name: 105W off-line programmable driver

Product Model: X6-105M100
 X6-105V100

Rev. B.2

Address: XiLi Songbai Road 1061, Nanshan
District, Shenzhen City, Guangdong
Province, P.R.China

Post Code: 518108

TEL: 0755-27657000

FAX: 0755-27657908

E-mail: info@mosopower.com

Web site: <http://www.mosopower.com>

Prepared By	Checked By	Approved By