

Description

The N7L series is specifically designed for industrial lighting applications, non-isolated design, operating in constant current with high power factor and a universal input voltage range of 90–305Vac. With 0-10V/PWM/ resistance dimming. The compact housing and high efficiency allow the drivers to operate with high reliability, while featuring input surge, output over voltage, short circuit and over temperature protection..



Product Features

- Universal input voltage: 90–305Vac ;
- Full power work range: 120–277Vac;
- Constant current design , Efficiency up to 96%;
- 3-in-1 dimmable: 0–10V / PWM / Rx;
- Dim-to-off;
- High surge protection: 6KV line-line, 6KV line-earth;
- 12V/0.2A auxiliary power supply;
- Output and Dimming Signal Isolating;
- Protections: SCP / OVP / OTP;
- 5 years warranty;

Application

Road and street lighting
 Tunnel lighting
 Area and flood lighting
 High-bay lighting

Models

Model Number	Input Voltage Range (Vac)	MAX Output Power (W)	Output Voltage Range (Vdc)	Full Power Output Current Range (A)	Default Current(A)	Eff. (Typ.)	PF(Typ.)	THD(Typ.)
N7L-320M260A12	90–305	320	180–260	1.23–1.48	1.33	96%	0.97	10%

Notes:

[1]. M means 0-10V/PWM/Rx dimming.

[2]. A12 means 12Vdc aux and Dim-to-off(Options available).

[3]. All specifications are measured at 25°C ambient temperature, input voltage 230Vac, and the typical value tested at full load, if no specific note.

Input Specifications

Parameter	Min	Typ.	Max	Notes
Input Voltage Range	90Vac	120-277Vac	305Vac	
Full Power Work Range	120Vac	-	277Vac	Refer to Output Power vs. Input Voltage curve
Input Frequency AC	47Hz	50/60Hz	63Hz	
Max Input Current	-	-	3.8A	120~277Vac & 100% load
Max Input Power	-	-	380W	120~277Vac & 100% load
Leakage Current	-	-	0.70mA	IEC 60598-1; 240Vac/60Hz
Leakage Current	-	-	0.75MIU	UL 8750; 277Vac/60Hz
Inrush Current	-	-	100A	230Vac, 100% load
Standby Power Consumption	-	-	0.5W	230Vac , dimming off and auxiliary source without load
Power Factor (PF)	0.90	0.97	0.99	120-277Vac , 50-60Hz , 80%-100% load
Total Harmonic Distortion (THD)	-	10%	15%	120-277Vac , 50-60Hz , 80%-100% load
MCB(B16)	-	4	-	230Vac; 100%load

Output Specifications

Parameter	Min	Typ.	Max	Notes
Output Voltage Range	180Vdc	-	260Vdc	
Open Circuit Voltage	-	-	310Vdc	
Output Current Range	1.04A	-	1.48A	
Full Power Current Range	1.23A	-	1.48A	
Current Accuracy	-8%	-	+8%	
Total Output Current Ripple (pk-pk)	-	10%	15%	20MHz BW full load & LED load the LED load ripple is slightly different for different leds
Startup Overshoot Current	-	-	10%	120-277Vac full load condition, LED load
Line Regulation	-5%	-	+5%	25°C±10°C ambient temperature, input changes from 120Vac to 277Vac
Load Regulation	-5%	-	+5%	Load varies from 70% to 100% with 230Vac Input at 25°C±10°C ambient temperature
Turn-on Delay Time	-	-	1.0s	120-277Vac, 100% load

General Specifications

Parameter	Min	Typ.	Max	Notes
Efficiency@120Vac	92%	93.5%	-	100% load, 25°C ambient temperature
Efficiency@230Vac	93%	95%	-	100% load, 25°C ambient temperature
Efficiency@277Vac	93%	96%	-	100% load, 25°C ambient temperature
Mean Time Between Failure	-	200Khours	-	25°C±10°C ambient temperature , 230Vac , 80% load condition (MIL-HDBK-217/SR-332)
Lifetime	-	50Khours	-	230Vac & 100% load , Tc 75°C , refer to lifetime vs. case temperature curve
Operating Tc for Safety Tc_s	-40°C	-	+90°C	
Operating Tc for Warranty Tc_w	-40°C	-	+75°C	5-year warranty shell temperature, humidity: 10% to 95% RH
Storage Temperature Ta	-40°C	-	+85°C	Humidity: 5% to 100% RH
Altitude	-60m	-	4000m	
Over Temperature Protection Tc	90°C	95°C	100°C	Decreases output current, returning to normal after over temperature is removed.
Short Circuit Protection	-	-	15W	Constant current mode. The output shall return to normal when the fault condition is removed.
Dimensions (L*W*H)	197*66*34mm			
Net Weight	820±50g/PCS			
Package (L*W*H)	500*310*174mm; 24PCS/Ctn, Gross Weight: 20Kg			

Dimming

Parameter	Min	Typ.	Max	Notes
Absolute Maximum Voltage	-	10V	15V	On the Vdim (+) Pin
Source Current on Vdim (+)Pin	-	100uA	200uA	
Dimming Range	10% I _{omax}	-	100% I _{set}	
Suggest Dimming Input 0-10V	0V	-	10V	
Turn-on Voltage	1.0V	-	1.3V	
Turn-off Voltage	0.6V	-	0.9V	
PWM in High Level	9.7V	-	10.3V	
PWM in Low Level	0V	-	0.3V	
PWM in Frequency Range	1KHz	-	2KHz	
PWM in Duty Cycle	1%	-	99%	
Turn-on Duty Cycle	10%	-	13%	
Turn-Off Duty Cycle	7%	-	9%	
Rx Range	0	-	100K	
Auxiliary	10.8V	12V	13.8V	12Vdc/200mA

Safety Specification

Parameter	Min	Typ.	Max	Notes
Dielectric Strength (Input-Ground)	-	1600Vac	-	60s , Current not exceeding 5mA
Dielectric Strength (Input-Dimming)	-	3000Vac	-	60s , Current not exceeding 5mA
Grounding Resistance	-	-	0.1Ω	25°C±10°C Ambient Temperature, pass 25A Current, 60s.
Insulation Resistance	10MΩ	-	-	Output-PE, 500Vdc/60s/25°C

Safety Compliance

Safety Category	Standards	Approved	Notes
CCC	GB19510.1,GB19510.14		
CE	EN61347-1, EN61347-2-13, EN62493	√	
ENEC	EN61347-1, EN61347-2-13, EN62384	√	
CB	IEC61347-1, IEC61347-2-13	√	
BIS	IS 15885(PART 2/SEC 13)		
UL	UL 8750	√	
CUL	CSA C22.2 No.250.13	√	
KC	K61347-1, K61347-2-13		
PSE	J61347-1, J61347-2-13		
SAA	AS/NZS IEC 61347.2.13	√	
SAA	AS/NZS 61347.1	√	

EMC Compliance

EMC Category	Standards	Approved	Notes
CCC	GB/T 17743, GB 17625.1		
CE	EN 55015	√	
CE	EN 61000-3-2, EN 61000-3-3	√	
CE	EN61000-4-2,3,4,5,6,11	√	
CE	EN 61547	√	
KC	K61547		
KC	K00015		
PSE	J55015		
FCC	FCC part 15	√	
Surge Shock Immunity	ANSI/C82.77-5-2017		
Ringing Wave			

RoHS

Our products comply with reference to RoHS Directive (EU) 2015/863 amending 2011/65/EU.

Inrush Current

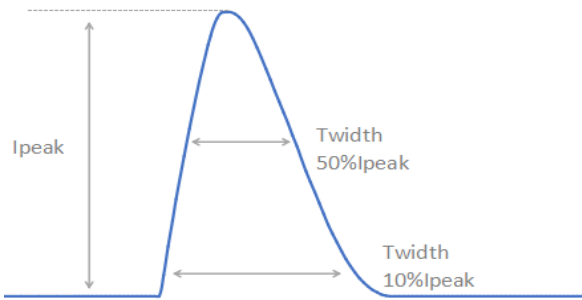

V_{in}	I_{peak}	$T(@10\% \text{ of } I_{peak})$	$T(@50\% \text{ of } I_{peak})$
230Vac	92A	685 μ s	345 μ s

Output Voltage vs. Output Current

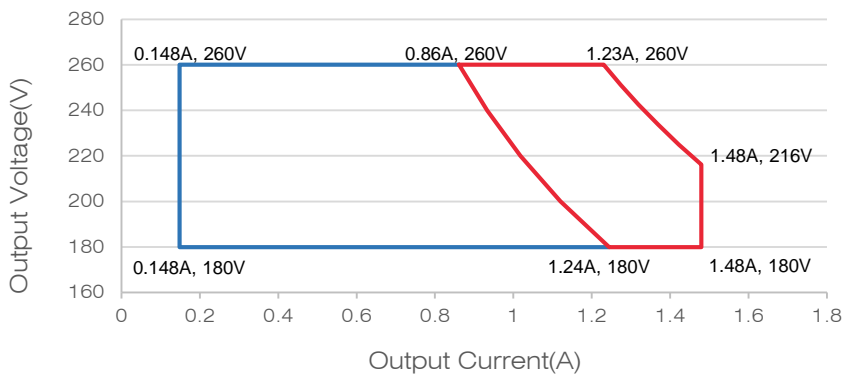

Red curve: good performance area

Output Power vs. Input Voltage

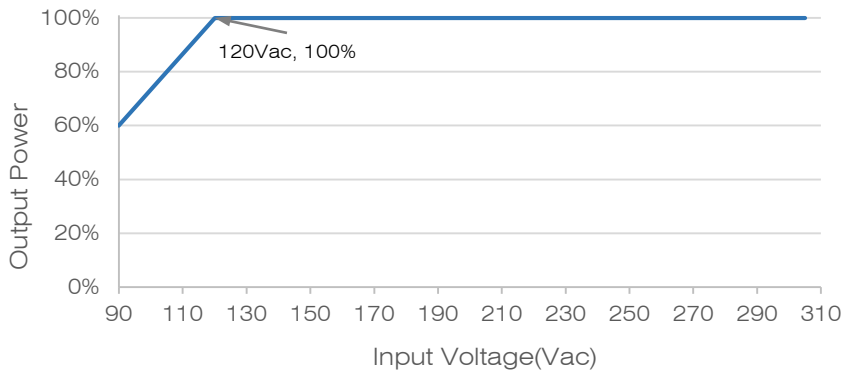

Efficiency vs. Load

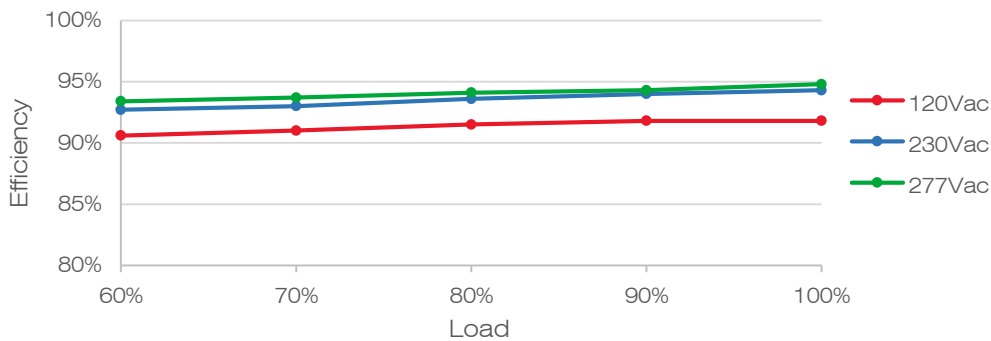

PF vs. Load

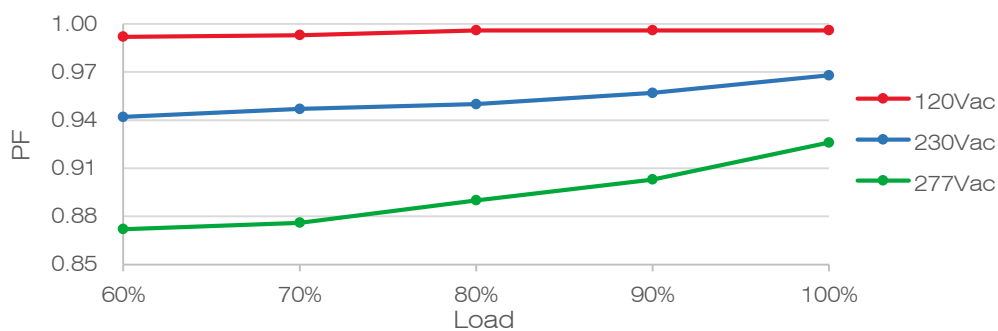

THD vs. Load

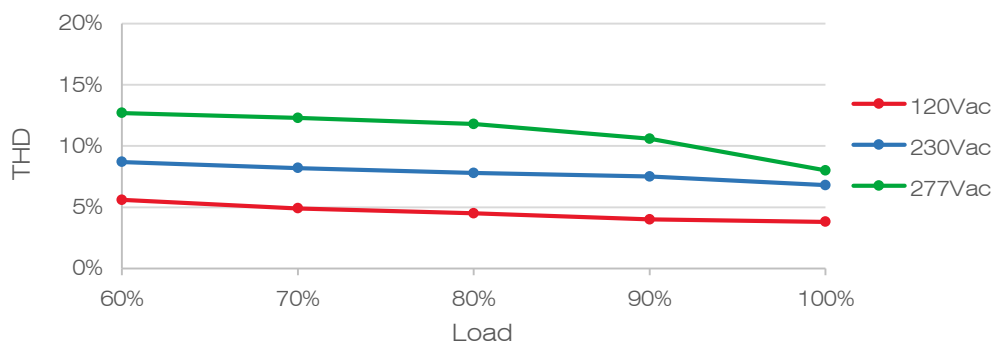

Output Power vs. Case Temperature

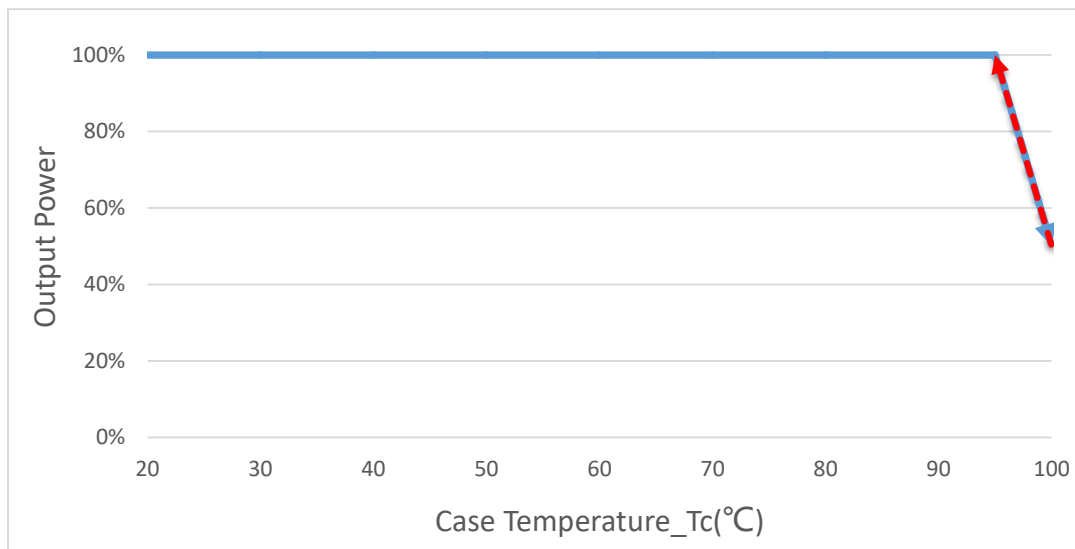

Lifetime vs. Case Temperature

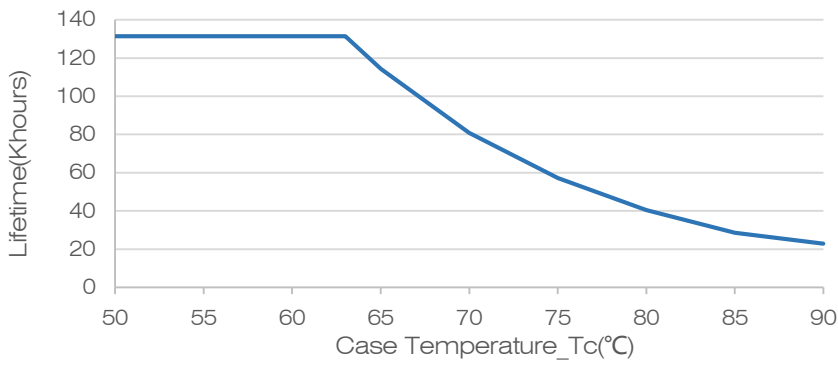

0-10V/PWM Dimming

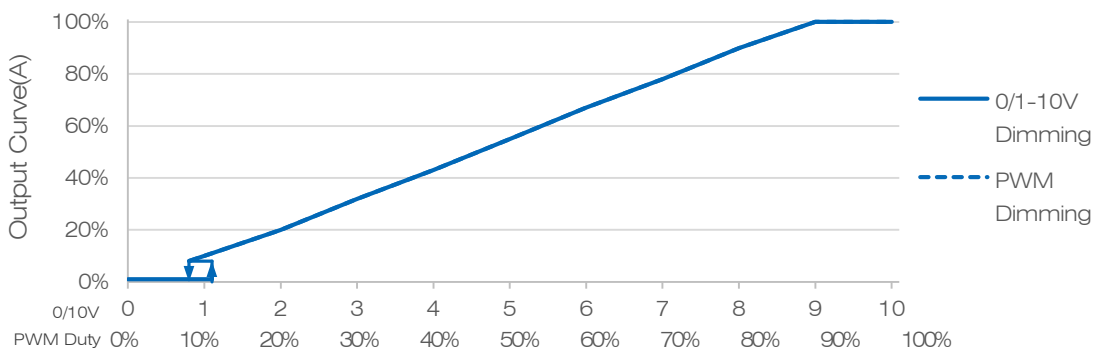

Notes: Afterglow may appear after switching off dimming due to the difference of lamp panel. Thus, lighting fixture grounding test is suggested.

Mechanical Outline

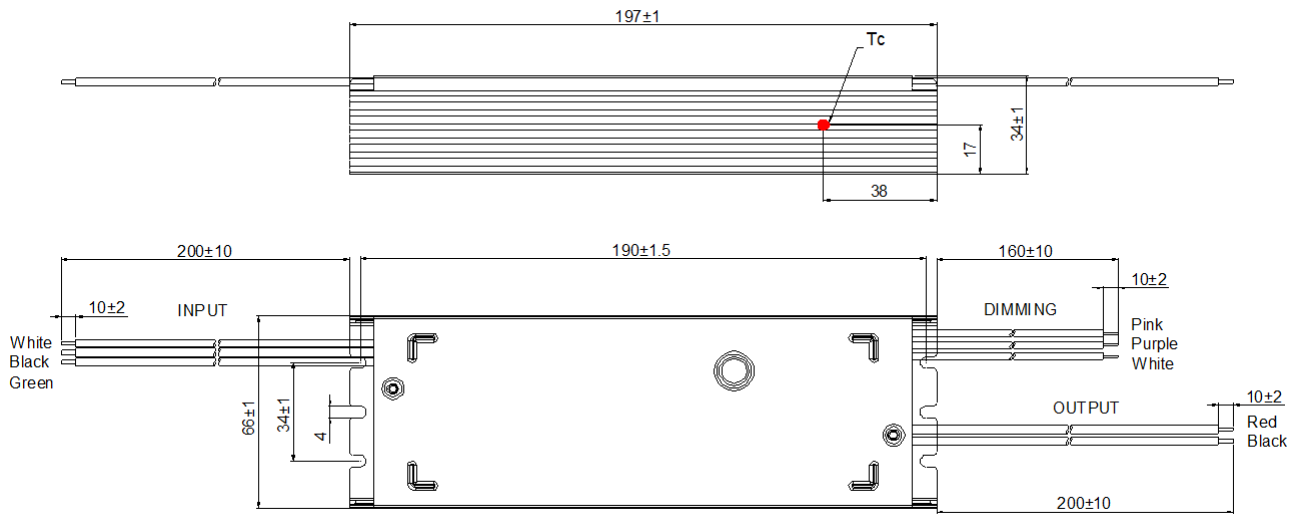

Notes:

- [1]. In order to meet the requirements of the "derating curve" and "maximum ambient temperature of 50 °C", it is necessary to add auxiliary heat dissipation devices with a recommended heat dissipation area of 380cm² and the volume is 115cm³; It is also necessary to add thermal conductive silicone grease between the heat sink and LED driver to ensure a tight fit with the auxiliary heat sink.
- [2]. The pressure resistance of LED beads and aluminum substrate should be greater than 2KV_{ac}.

Specification

Input	UL 1015 18AWG L=200±10mm Y=10±2mm	UL
Output	UL 1015 18AWG L=200±10mm Y=10±2mm	UL
Dimming	UL 1015 22AWG L=160±10mm Y=10±2mm	UL

Label

INPUT

N White

L Black

G Green

MOSO[®] N7L-320M260A12
Constant current type LED DRIVER
Integrated SPD

INPUT	100-277V~ 50/60Hz, 3.8A Max. PF: 0.9C-0.95. 380W
OUTPUT	180-260V~ 0.148-1.48A Uout Max: 310V~ Max. Power: 320W
tc:	90°C

Suitable for Dry, Damp and Wet locations
SHENZHEN MOSO ELECTRONICS TECHNOLOGY CO., LTD
No.1061, Songbai Road, Xili Town, Nanshan District,
Shenzhen, CHINA
CLASS P: " For connections Use Wire Rated for at
Least 90°C(194°F)or equivalent

UL US LISTED E332669

RoHS

CE MADE IN CHINA For LED module only

OUTPUT

Purple DIM"+"

Pink DIM"-"

White 12V"+"

(12V 200mA)

Red Vo"+"

Black Vo"-"

IoADJ

Class P

Note:

Nameplate is laser engraved.

Version

A.1	First release	2023-05-22

Specification for Approval

Product Name: 320W Linear Non-isolated Driver

Product Model: N7L-320M260A12

Rev: A.1

Address:XiLiSongbai Road 1061, Nanshan District, Shenzhen City, Guangdong, China

Tel: 0755-27657000

FAX: 755-27657908

E-mail:info@mosopower.com

Web Site:http://www.mosopower.com

Prepared By	Checked By	Approved By

Specification for Approval

Product Name: 320W Linear Non-isolated Driver

Product Model: N7L-320M260A12

Rev: A.1

CUSTOMER AUTHORIZED SIGNATURE		
Tested By	Checked By	Approved By
(Company seal)Return one copy to MOSO with approved signature and company seal.		

Address:XiLiSongbai Road 1061, Nanshan District, Shenzhen City, Guangdong, China

Tel: 0755-27657000

FAX: 755-27657908

E-mail:info@mosopower.com

Web Site:http://www.mosopower.com

Prepared By	Checked By	Approved By