

## Specification for Approval

Product Name: 150W Constant Voltage LED Driver  
Product Model: LSV-150B024  
Product Code: MS000151-V0  
Rev.: D.2  
Sample Date:

CUSTOMER AUTHORIZED SIGNATURE		
Tested By	Checked By	Approved By
(Company seal)Return one copy to MOSO with approved signature and company seal.		

No.1061, Songbai Road, Xili, Nanshan  
Address: District, Shenzhen City, Guangdong Province,  
P.R.China

TEL: 0755-27657000

E-mail: wcx@mosopower.com

Post  
Code: 518108

FAX: 0755-27657908

Web http://www.mosopower.co  
site: m

Prepared By	Checked By	Approved By



## Product Specification

Product Name: 150W Constant Voltage LED Driver  
Product Model: LSV-150B024  
Product Code: MS000151-V0  
Rev. D.2

Address: No.1061, Songbai Road, Xili, Nanshan District,  
Shenzhen City, Guangdong Province,  
P.R.China

TEL: 0755-27657000

E-mail: wcx@mosopower.com

Post  
Code: 518108

FAX: 0755-27657908

Web site: <http://www.mosopower.com>

Prepared By	Checked By	Approved By



---

---

## Contents

<b>1</b>	<b>Scope</b> .....	<b>1</b>
<b>2</b>	<b>Input Characteristics</b> .....	<b>1</b>
	2. 1 Input Voltage and Frequency .....	1
	2. 2 AC Input Current .....	1
	2. 3 Inrush Current(Cold Start) .....	1
	2. 4 Power Factor .....	1
	2. 5 Efficiency .....	1
	2. 6 Input Current THD .....	1
<b>3</b>	<b>Output Characteristics</b> .....	<b>1</b>
	3. 1 Output Power .....	1
	3. 2 Output voltage and Current .....	2
	3. 3 Output Voltage Ripple .....	2
	3. 4 Turn-On Delay Time .....	2
	3. 5 Output Voltage Overshoot .....	2
	3. 6 Line Regulation .....	2
	3. 7 Load Regulation .....	2
<b>4</b>	<b>Protection</b> .....	<b>2</b>
	4. 1 Short Circuit Protection .....	2
	4. 2 Over Temperature Protection .....	2
	4. 3 Over Current Protection .....	2
	4. 4 Over Voltage Protection .....	2
<b>5</b>	<b>Safety and Electromagnetic Compatibility</b> .....	<b>3</b>
	5. 1 Safety Standards .....	3
	5. 2 Electromagnetic Compatibility Standards .....	3
<b>6</b>	<b>Details of Safety Specifications</b> .....	<b>3</b>
	6. 1 Dielectric Strength .....	3
	6. 2 Grounding Resistance .....	4
	6. 3 Leakage Current .....	4
	6. 4 Insulation Resistance .....	4
	6. 5 Surge Immunity Test .....	4
<b>7</b>	<b>Environmental Specifications</b> .....	<b>4</b>
	7. 1 Operated Temperature And Humidity .....	4
	7. 2 Storage Temperature And Humidity .....	4
	7. 3 Vibration .....	4
	7. 4 Degrees of Protection .....	4
<b>8</b>	<b>Reliability</b> .....	<b>4</b>
	8. 1 Mean Time Between Failure (MTBF) Qualification (According as MIL-HDBK-217F Standards) .....	4

---

---

8.2 Life Time Qualification .....	4
<b>9 Temperature vs. Load Curve .....</b>	<b>5</b>
<b>10 Input voltage vs. Load Curve .....</b>	<b>6</b>
<b>11 Efficiency vs. Load Curve .....</b>	<b>6</b>
<b>12 Power Factor vs. Load Curve .....</b>	<b>7</b>
<b>13 Power Factor vs. Input Voltage Curve .....</b>	<b>7</b>
<b>14 Mechanical Outline Drawing .....</b>	<b>8</b>
<b>15 Label .....</b>	<b>8</b>
<b>16 Weight .....</b>	<b>8</b>

## 1 Scope

This document defines the electrical, mechanical and environmental specifications of a 150W constant voltage LED driver. The LED driver shall meet the RoHS requirement.

This enclosure of LED driver is:

With AL Case       With Plastic Case       Open Frame       Others

Note: For all items do not list test temperature in this document, all tests are under  $25^{\circ}\text{C}\pm 10^{\circ}\text{C}$  ambient temperature.

## 2 Input Characteristics

### 2.1 Input Voltage and Frequency

Item	Minimum	Nominal	Maximum
Input Voltage	90Vac	100-277Vac	305Vac
Input Frequency	47Hz	60Hz/50Hz	63Hz

### 2.2 AC Input Current

Under  $25^{\circ}\text{C}\pm 10^{\circ}\text{C}$  ambient temperature, rated input and output range (reference input voltage –Load curve), maximum AC input current value is 2.0A.

### 2.3 Inrush Current(Cold Start)

Under  $25^{\circ}\text{C}\pm 10^{\circ}\text{C}$  ambient temperature, 230Vac input, the peak value of the inrush current is less than 75 A.

### 2.4 Power Factor

2.4.1 Under  $25^{\circ}\text{C}\pm 10^{\circ}\text{C}$  ambient temperature, 230Vac input, 100% load, the typical value of power factor is 0.96; the minimum value is 0.95(reference Power Factor vs. Load Curve).

### 2.5 Efficiency

2.5.1 Under  $25^{\circ}\text{C}\pm 10^{\circ}\text{C}$  ambient temperature, 230Vac input, 100% load, the typical value of efficiency is 91% the minimum value of efficiency is 89%(reference Efficiency vs. Load Curve).

### 2.6 Input Current THD

2.6.1 Under  $25^{\circ}\text{C}\pm 10^{\circ}\text{C}$  ambient temperature, 230Vac input, 70~100% load, the maximum value of input current THD is 15%(reference THDi Curve).

## 3 Output Characteristics

### 3.1 Output Power

Under full input voltage range(reference Input Voltage vs. Load Curve), the maximum value of output power is 150 W.

### 3.2 Output voltage and Current

Item(Unit)	Value	Test Condition(Under 25°C±10°C Ambient Temperature)
Maximum Output Power(W)	150	full input voltage range
Rated Output Voltage(V)	24	full input voltage range
Load Current Range(A)	0~6.25	full input voltage range
Output Voltage Precision	±5%	full input voltage range, full load range
No Load Voltage(V)	≤25.2	full input voltage range

### 3.3 Output Voltage Ripple

Under 25°C±10°C ambient temperature, 230Vac input, 100% load, the ratio of output voltage ripple peak value and average output voltage is less than 3%.

### 3.4 Turn-On Delay Time

Under 25°C±10°C ambient temperature, 230Vac input, 100% load, turn-on delay time at cold start is less than 0.5s, 115Vac input, at cold start is less than 1s.

### 3.5 Output Voltage Overshoot

Under 25°C±10°C ambient temperature, 100% load, turn-on at full input voltage range, the ratio of output voltage overshoot and rated output voltage is less than 10%.

### 3.6 Line Regulation

Under 25°C±10°C ambient temperature, 100% load, change input from 115Vac to 305Vac, line regulation is less than 3%.

### 3.7 Load Regulation

Under 25°C±10°C ambient temperature, 230Vac input voltage, change load from 50% to 100%, load regulation is less than 3%.

## 4 Protection

### 4.1 Short Circuit Protection

The input power shall decrease when the output rail short, the power supply shall not be damaged.

### 4.2 Over Temperature Protection

When the Tc is over 90°C, the driver shuts off automatically and enters protection status.

### 4.3 Over Current Protection

The product will enter hiccup status when 2.0 maximum load current applied to the output, and the product shall be self-recovery when the fault condition is removed.

### 4.4 Over Voltage Protection

When the output voltage is over 1.1-1.3 Rated Load Voltage, the driver shuts off automatically and enters

protection status, the driver will work normally after fault condition removed and AC input reapply.

## 5 Safety and Electromagnetic Compatibility

### 5.1 Safety Standards

Safety Category	Country and region	Standards	Accordant
CCC	China	GB19510.1	
		GB19510.14	
CE	Europe	EN61347-1	√
		EN61347-2-13	
CB	CB member	IEC61347-1	
		IEC61347-2-13	
UL	America	UL 8750	
		UL 1310 (Class 2 Power Units)	
		UL 1012	
CUL	Canada	CSA C22.2 No.107.1-01	
		CSA C22.2 No.223-M91 (Power Supplies With Extra-Low-Voltage Class 2 Outputs)	
KC	Korea	K61347-1	
		K61347-2-13	
		K62384	
PSE	Japan	J61347-1	
		J61347-2-13	
SAA	Australia	IEC 61347-2-13	
		AS/NZS 61347.1	

### 5.2 Electromagnetic Compatibility Standards

EMC Certification	Country and region	Standards	Accordant
CCC	China	GB 17743	
		GB 17625.1	
FCC	America	FCC part 15	
CE	Europe	EN 55015	√
		IEC 61000-3-2	
		IEC 61000-3-3	
		IEC 61547	
KC	Korea	K61547	
		K00015	
PSE	Japan	J55015	

## 6 Details of Safety Specifications

### 6.1 Dielectric Strength

6.1.1 input to output : 3750Vac, 60s, current is less than 10mA;

6.1.2 input to PE:1600Vac, 60s, current is less than 10mA;

6.1.3 output to PE: 1600Vac, 60s, current is less than 10mA.



**Note:** 25°C±10°C ambient temperature, I/P: L,N Line;O/P: Vo+, Vo-.

## 6.2 Grounding Resistance

Under 25°C±10°C ambient temperature, pass 25A current for 60s, the measured grounding resistance is less than 0.1Ω.

## 6.3 Leakage Current

Leakage Current is defined as the current flowing through the ground wire. Under 25°C±10°C ambient temperature and 230Vac/50Hz input, the leakage current shall be less than 0.75mA.

## 6.4 Insulation Resistance

Under 25°C±10°C ambient temperature and less than 70% relative humidity, apply 500V dc voltage to each port of Input to output, input to GND, output to GND and last 60s, the insulation resistance is at least 100MΩ.

## 6.5 Surge Immunity Test

Under 25°C±10°C ambient temperature, L line to N line is 5000V, L line to FG is 10000V, N line to FG is 10000V.

# 7 Environmental Specifications

## 7.1 Operated Temperature And Humidity

Temperature: -40°C to +60°C ( please reference Temperature vs Load Curve); Relative Humidity: 20% to 95%, non-condensing.

## 7.2 Storage Temperature And Humidity

Temperature: -40°C to +85°C; Relative Humidity: 20% to 95%, non-condensing.

## 7.3 Vibration

10 to 500HZ Sweep at constant acceleration of 1.0G (depth: 3.5mm ) for 1 Hour for each of the perpendicular axes X, Y, Z.

## 7.4 Degrees of Protection

IP67

# 8 Reliability

## 8.1 Mean Time Between Failure (MTBF) Qualification (According as MIL-HDBK-217F Standards)

Mean time between failure is at least 200, 000 hours under 25°C ambient temperature, 230Vac input, and 80% load.

## 8.2 Life Time Qualification

The life time is at least 50, 000 hours, under 60°C case temperature, 230Vac input, and 100% load(reference Life vs.TC curve).

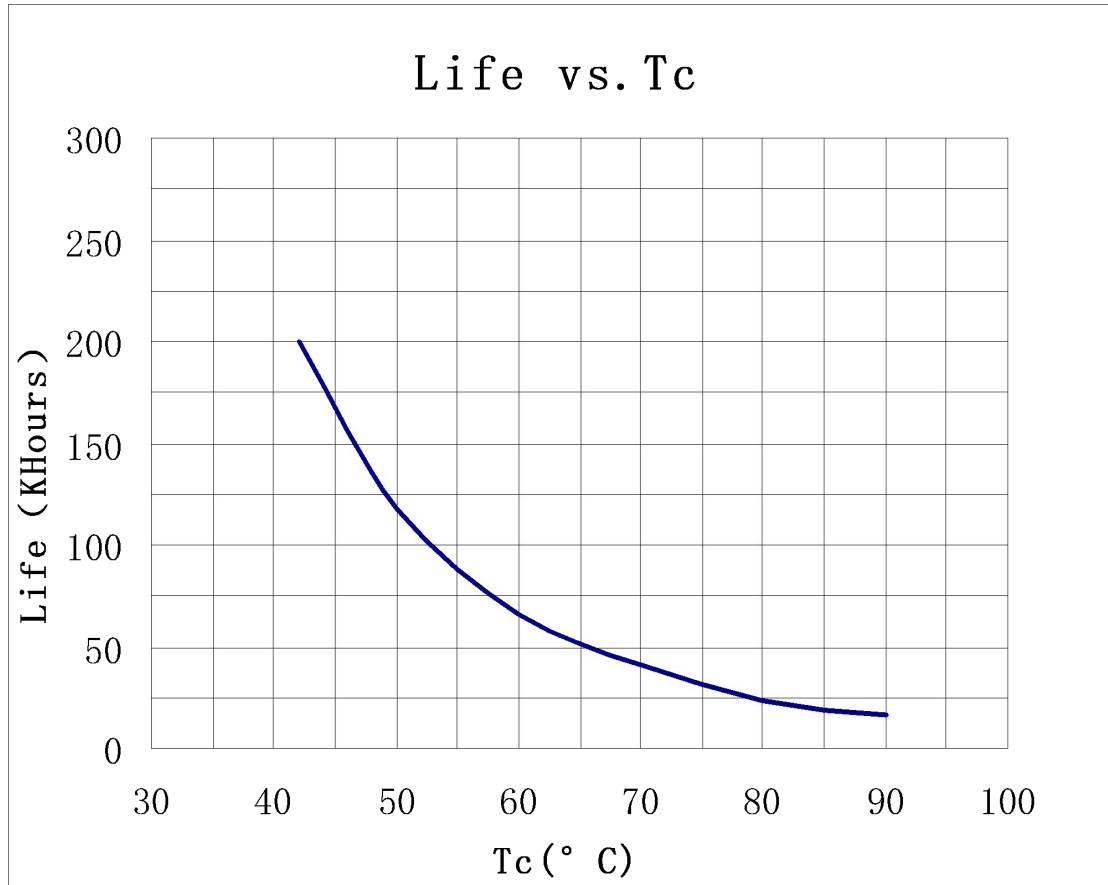

**9 Temperature vs. Load Curve**

Temperature vs. Load Curve

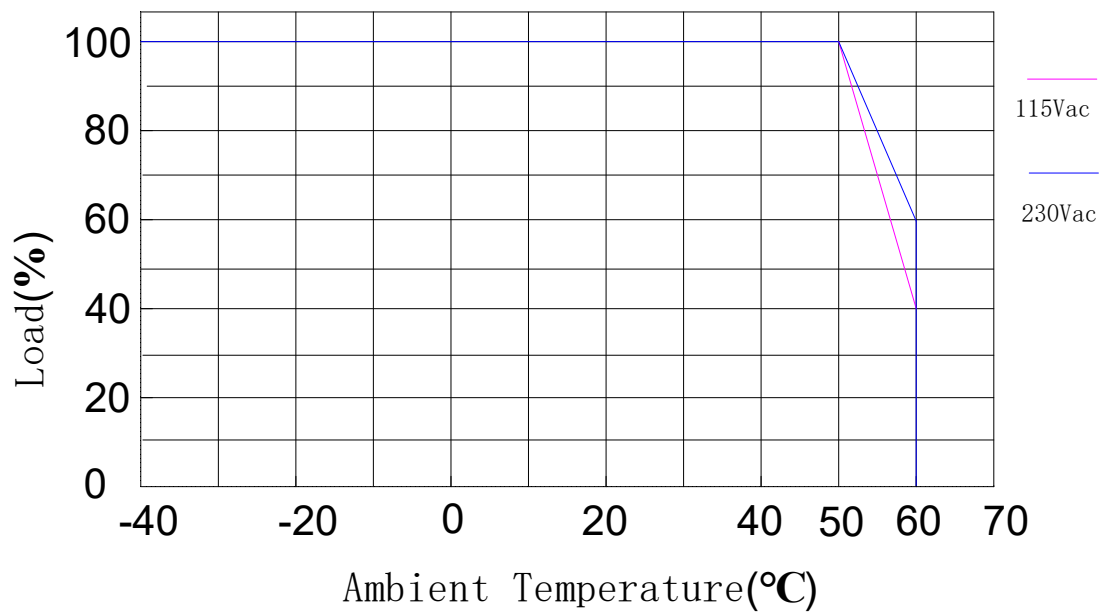

**10 Input voltage vs. Load Curve**

Input Voltage vs. Load Curve

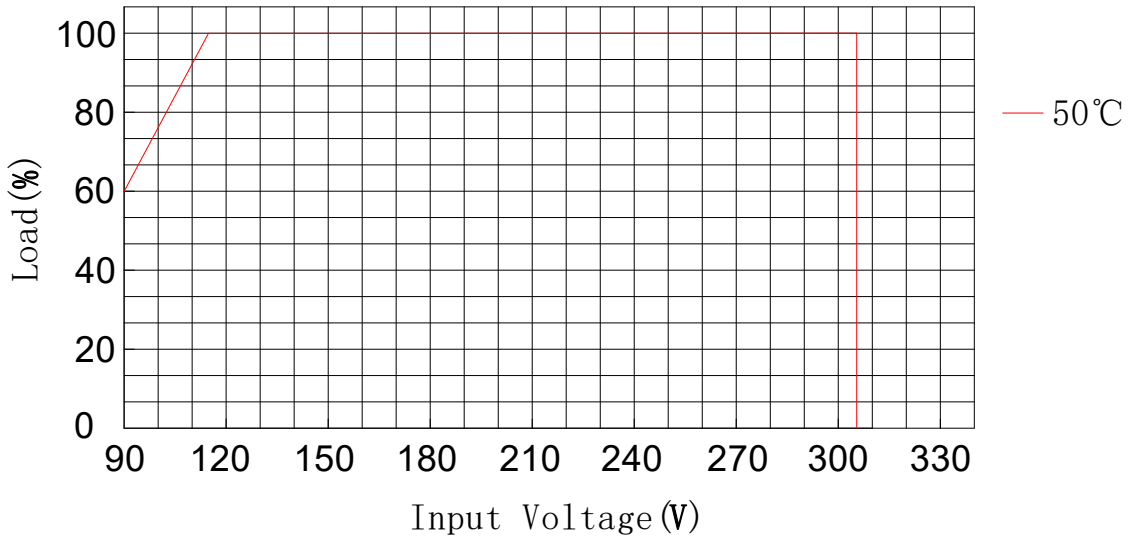

**11 Efficiency vs. Load Curve**

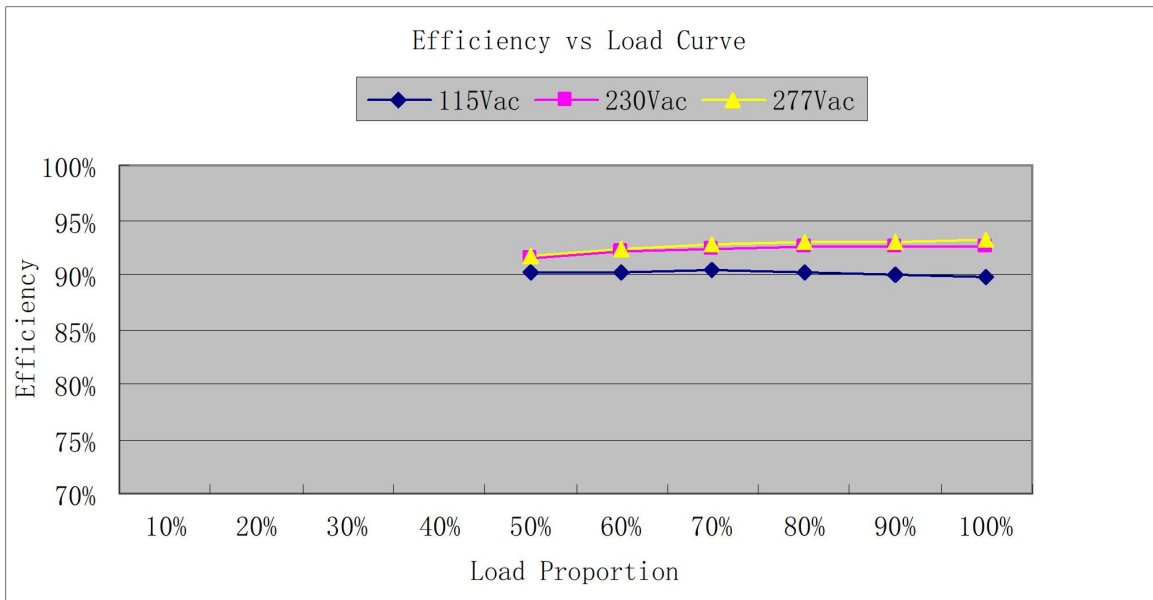

**12 Power Factor vs. Load Curve**

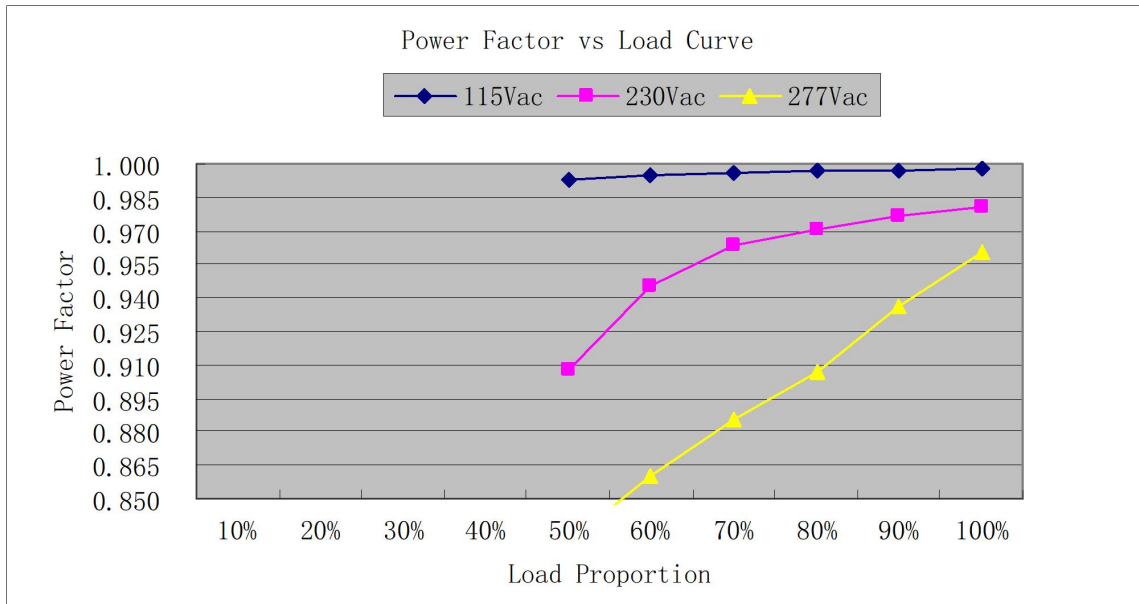

**13 THDi Curve**

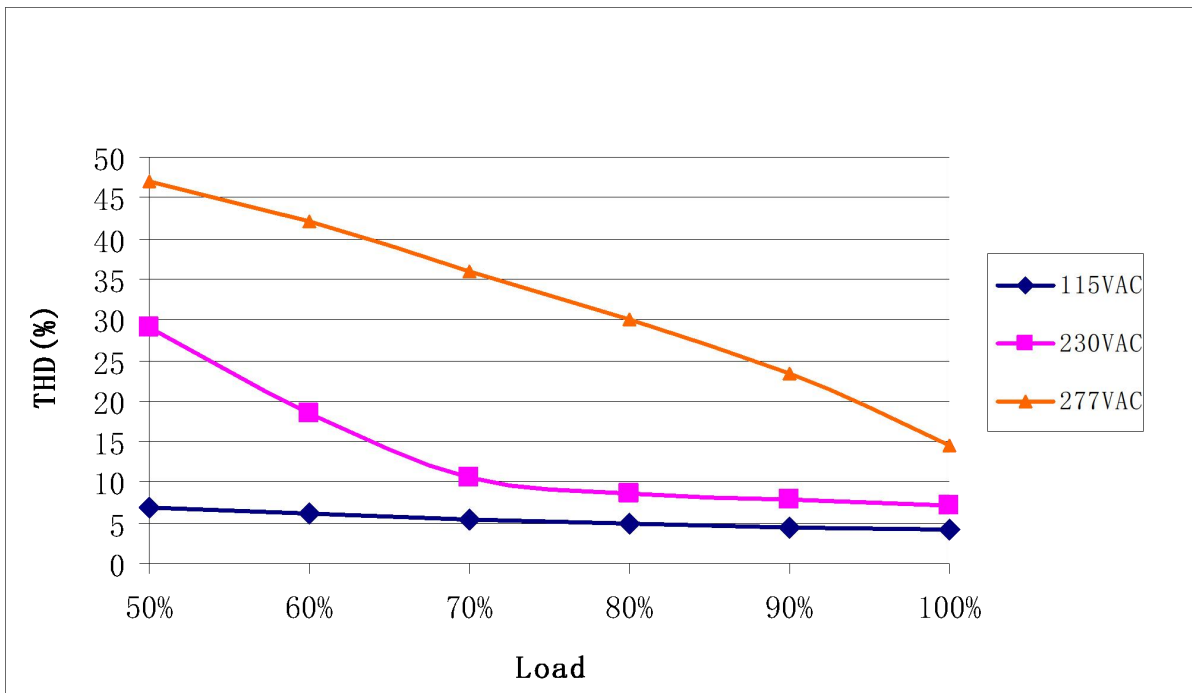

## 14 Mechanical Outline Drawing

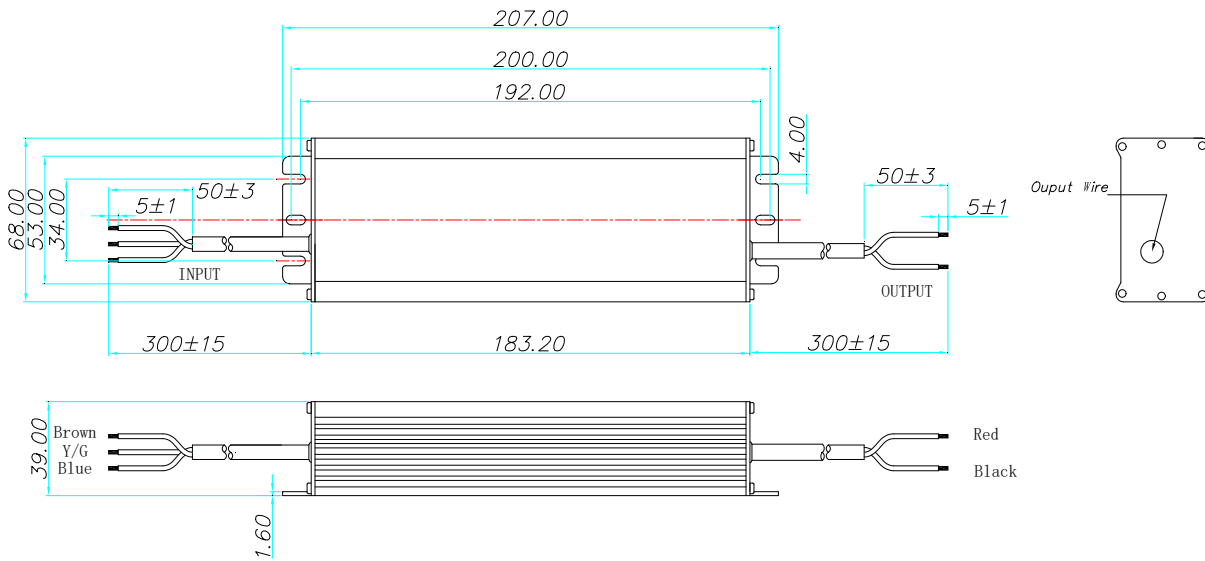

Wire	Specification
AC Input	CCC+VDE 3x1.0mm <sup>2</sup> L=300mm
DC Output	16AWG 2C L=300mm

## 15 Label



## 16 Weight

900±50g