

MOSO[®]

OUTDOOR LED DRIVER PRODUCT CATALOG

2026 V1.0



ABOUT MOSO

Shenzhen MOSO Electronics Technology Co., Ltd. is an outdoor LED driver solutions company (affiliated with the listed company MOSO Power Supply Technology Co., Ltd.). Since its establishment in 2009, it has become a reliable LED driver company trusted by customers. The company has more than 800 professional employees and has established three major production bases centred on Shenzhen (R&D headquarters), Huizhou (intelligent production base) and Vietnam (international capacity centre), forming a synergistic advantage of R&D innovation and large-scale production. To better serve global customers, MOSO Electronics has established more than 10 offices in Europe, North America, South America, India, Southeast Asia and other regions, as well as in Xiamen, Beijing, Zhongshan and other places in China, building a global service network. At the same time, the company's products are widely used in road lighting, industrial lighting, stadium lighting, horticulture lighting, landscape lighting, urban public lighting and other fields, and have been sold to more than 130 countries and regions around the world.

Always adhering to the concept of "innovation, intelligence and sustainable development", MOSO Electronics is committed to providing global customers with efficient and environmentally friendly lighting solutions, helping the world move towards a green and low-carbon future.

**800+**

Employees

**120+**

R&D Patent

**CNAS**

National-level Laboratory

**DALI**

Full Member of the DALI Alliance

**EPD**

Environmental Product Declaration

**EMC**

Preferred EMC Energy Performance Contracting Project

As a DALI Alliance Regular Member, MOSO delivers D4i-certified power solutions for roads, stadiums, and industrial lighting. Our U7, S6, S7, N8H and G6D series integrate cutting-edge DALI-2/D4i technologies, enabling seamless IoT control, energy efficiency, and unmatched reliability. Trusted in global projects, we drive innovation for a sustainable, intelligent future.

MOSO provides EPD verified products, our power solutions excel in sustainability. From raw materials to end-of-life, our products minimise carbon footprints, increase energy efficiency and meet EU CBAM/Green Deal standards. Transparent lifecycle data, verified by third parties, ensures environmental accountability. Globally trusted, MOSO enables industry to meet stringent green procurement requirements while reducing operational costs.



Global Operation Sites

● Headquarter ● Production Base ● Office ● Distributor



Headquarter-Shenzhen



Manufacturing Center-Vietnam



Manufacturing Center-Huizhou



Projects



▶ *Shanghai Urban Road Lighting Project*



▶ *Fuzhou Urban Road Lighting Project*



▶ *Hangzhou Urban Road Lighting Project*



▶ *Shenzhen-Zhongshan Corridor Lighting Project*



▶ *Petro China*



▶ *Yingde Football Training Base*



▶ *Beijing Daxing Airport*

Road Lighting LED Driver

X6N Series	08	
X6E-G Series	09	
X6 Series	10	
X7S Series	11	
X6S(XCP)Series	12	
X7E Series	13	
X6E Series	14	
X8D Series	15	
X6E D Series	16	
X7A Series	17	
U7+ Series	18	
U5 Series	19	
U6M Series	20	
X7P Series	21	
X6I Series	22	
X7I Series	23	
X6L Series	24	
IoT LED Driver	25	

Industrial Lighting LED Driver

G6T-(III) Series	27	
G6T-(II) Series	28	
G6D-(II) Series	29	
G6C-(II) Series	30	
G6H Series	31	
A5(MEP) Series	32	
N6H Series	33	
N7-II Series	34	
N7 Series	35	
N7L-II Series	36	
N7L Series	37	
N7C Series	38	
N5 Series	39	
N6(MNC) Series	40	

Stadium Lighting LED Driver

S6 600W Series	42
S6 880W Series	43

S6 RGBW Series	44	
S6 1200- 1800W Series	45	
S7 Series	46	
N8H Series	47	
X6 High Power Series	48	
X6H Series	49	

Horticulture Lighting LED Driver

P7 Series	51	
P1 Series	52	
P1H Series	53	
P6H Series	54	

Landscape Lighting LED Driver

V8 Series	56
V1(LSV) Series	57
V6E Series	58
V2 Series	59
V1R(MSV) Series	59

Industrial Power

T Series	61
----------	----

Urban Public Lighting LED Driver

X6 D Series	63
X6 VS Series	63
X6 DS Series	64









External Surge Protection Device

T1(MSP) Series	64
----------------	----

Appendix	65
----------	----

Road Lighting LED Driver



- X6N Series 
- X6E-G Series
- X6 Series 
- X7S Series
- X6S(XCP) Series
- X7E Series 
- X6E Series
- X8D Series 
- X6E D Series
- X7A Series
- U7+ Series 
- U5 Series 
- U6M Series 
- X7P Series
- X6I Series
- X7I Series
- X6L Series
- IoT LED Driver 



X6N Ultra-low Temperature Series Programmable Intelligent LED Driver



Features

- ▶ Input voltage: 90 ~ 305Vac;
- ▶ Isolated constant power design;
- ▶ 3-in-1 dimmable: 0-10V/1-10V/PWM (Dim-to-off optional);
- ▶ Timers dimming; Reverse dimming optional;
- ▶ 3 Timers dimming: Timing; Virtual Midnight; Self-Adaptive;
- ▶ Constant lumen output(CLO);
- ▶ Off-line programmable;
- ▶ Operating temperature: -60° C for normal operation.;
- ▶ Surge protection: DM 6KV, CM 10KV;
- ▶ Protections: Output SCP / OVP / OTP;
- ▶ Ingress protection rating: IP67;
- ▶ Suitable for dry / damp / wet locations;
- ▶ 5 years warranty.



Application

- ▶ Road Lighting , Industrial Lighting

Product Selection Guide

Model	Power(W)	Output voltage range(Vdc)	Full power output current range(A)	Default output	Typ. Eff.	Typ. PF	Dimensions (L*W*H)mm
X6N-075M056	75	28~56	1.35~2.15	28~36V/1.55A	91.0%	0.97	132*68*35
X6N-075M075	75	42~75	1.00~1.50	42~50V/1.50A	91.0%	0.97	132*68*35
X6N-075M108	75	54~108	0.70~1.05	54~72V/1.05A	92.0%	0.97	132*68*35
X6N-100M056	100	28~56	1.78~2.85	28~49V/2.05A	91.0%	0.97	138*68*35
X6N-100M100	100	56~100	1.00~1.50	56~67V/1.50A	92.0%	0.97	138*68*35
X6N-100M143	100	72~143	0.70~1.05	72~96V/1.05A	92.0%	0.97	138*68*35
X6N-150M056	150	28~56	2.70~4.30	28~32V/3.10A	92.5%	0.97	158*68*37
X6N-150M150	150	85~150	1.00~1.50	85~100V/1.50A	93.5%	0.97	158*68*37
X6N-150M214	150	115~214	0.70~1.05	115~143V/1.05A	93.5%	0.97	158*68*37
X6N-200M056	200	30~56	3.57~5.70	30~48V/4.15A	93.0%	0.97	178*68*37
X6N-200M200	200	120~200	1.00~1.50	120~133V/1.50A	93.5%	0.97	178*68*37
X6N-200M286	200	156~286	0.70~1.05	156~190V/1.05A	93.5%	0.97	178*68*37
X6N-240M056	240	30~56	4.30~6.85	30~48V/5.00A	93.5%	0.97	194*68*37
X6N-240M240	240	130~240	1.00~1.50	130~160V/1.50A	93.5%	0.97	194*68*37
X6N-240M343	240	171~343	0.70~1.05	171~228V/1.05A	93.5%	0.97	194*68*37
X6N-320M056	320	28~56	5.71~7.50	28~56V/5.00A	94.0%	0.97	244*78*42
X6N-320M457	320	228~457	0.70~1.05	228~457V/0.70A	95.0%	0.97	244*78*42

Note:

M means 0-5V/0-10V/PWM/Timer dimming.

X6E-G Series Programmable Intelligent LED Driver



Features

- ▶ Input voltage: 90 ~ 305Vac;
- ▶ Isolated constant power design;
- ▶ 3-in-1 dimmable: 0-10V/1-10V/PWM (Dim-to-off optional);
- ▶ Timers dimming; Reverse dimming optional;
- ▶ 3 Timers dimming: Timing; Virtual Midnight; Self-Adaptive;
- ▶ Constant lumen output(CLO);
- ▶ Off-line programmable;
- ▶ (M types) output current adjustable by programmer, (V types) output current adjustable by built-in potentiometer;
- ▶ Surge protection: DM 6KV, CM 10KV;
- ▶ Protections: Output SCP / OVP / OTP;
- ▶ Ingress protection rating: IP67;
- ▶ Suitable for dry / damp / wet locations;
- ▶ 5 years warranty.

Class P **Type HL**
CE **CB** **SAA** **EAC**

Application

- ▶ Road Lighting , Industrial Lighting and Landscape Lighting

Product Selection Guide

Model	Power(W)	Output voltage (Vdc)	Full power current adjustable range(A)	Default output	Typ. Eff.	Typ. PF	Dimensions (L*W*H)mm
X6E-026M056-G	26	28~56	0.46~0.75	28~38V/0.70A	86.0%	0.95	105*65*32
X6E-040M056-G	40	28~56	0.72~1.15	28~56V/0.70A	88.0%	0.97	105*65*32
X6E-050M056-G	50	28~56	0.90~1.50	28~56V/0.70A	88.0%	0.97	118*65*32
X6E-050M084-G	50	42~84	0.60~1.05	42~71V/0.70A	89.0%	0.97	118*65*32
X6E-060M056-G	60	28~56	1.07~1.72	28~48V/1.25A	89.0%	0.97	118*65*32
X6E-060M086-G	60	43~86	0.70~1.10	42~86V/0.70A	89.0%	0.97	118*65*32
X6E-075Y056-G	75	28~56	1.35~2.15	28~36V/1.55A	91.0%	0.97	132*68*35
X6E-075Y075-G	75	42~75	1.00~1.50	42~50V/1.50A	91.0%	0.97	132*68*35
X6E-075Y108-G	75	54~108	0.70~1.05	54~72V/1.05A	92.0%	0.97	132*68*35
X6E-100Y056-G	100	28~56	1.78~2.85	28~49V/2.05A	91.0%	0.97	138*68*35
X6E-100Y100-G	100	56~100	1.00~1.50	56~67V/1.50A	92.0%	0.97	138*68*35
X6E-100Y143-G	100	72~143	0.70~1.05	72~96V/1.05A	92.0%	0.97	138*68*35
X6E-150Y056-G	150	28~56	2.70~4.30	28~32V/3.10A	92.5%	0.97	158*68*37
X6E-150Y150-G	150	85~150	1.00~1.50	85~100V/1.50A	93.5%	0.97	158*68*37
X6E-150Y214-G	150	115~214	0.70~1.05	115~143V/1.05A	93.5%	0.97	158*68*37
X6E-200Y056-G	200	30~56	3.57~5.70	30~48V/4.15A	93.0%	0.97	178*68*37
X6E-200Y200-G	200	120~200	1.00~1.50	120~133V/1.50A	93.5%	0.97	178*68*37
X6E-200Y286-G	200	156~286	0.70~1.05	156~190V/1.05A	93.5%	0.97	178*68*37
X6E-240Y056-G	240	30~56	4.30~6.85	30~48V/5.00A	93.5%	0.97	194*68*37
X6E-240Y240-G	240	130~240	1.00~1.50	130~160V/1.50A	93.5%	0.97	194*68*37
X6E-240Y343-G	240	171~343	0.70~1.05	171~228V/1.05A	93.5%	0.97	194*68*37
X6E-320M056-G	320	28~56	5.71~7.50	28~56V/5.00A	94.0%	0.97	244*78*42
X6E-320M457-G	320	228~457	0.70~1.05	228~457V/0.70A	95.0%	0.97	244*78*42

Note:

Y=M means 0-5V/0-10V/PWM/Timer dimming, Y=V means non-dimmable, adjustable output current with potentiometer.

X6 Series Offline Programmable Intelligent LED Driver



Features

- ▶ Input voltage: 90 ~ 305Vac;
- ▶ Isolated constant power design;
- ▶ 3-in-1 dimmable: 0-10V/1-10V/PWM (Dim-to-off optional);
- ▶ Timers dimming; Reverse dimming optional;
- ▶ 3 Timers dimming: Timing; Virtual Midnight; Self-Adaptive;
- ▶ Constant lumen output(CLO);
- ▶ External NTC supported (Optional);
- ▶ Off-line programmable;
- ▶ (M types) output current adjustable by programmer, (V types) output current adjustable by built-in potentiometer;
- ▶ Surge protection: DM 6KV, CM 10KV;
- ▶ DM 4KV, CM 6KV(42W-60W);
- ▶ Protections: Output SCP / OVP / OTP;
- ▶ Ingress protection rating: IP67;
- ▶ Suitable for dry / damp / wet locations;
- ▶ Lifetime: 50,000/100,000 hours optional;
- ▶ 5 years warranty.

Class P
Type HL

Application

- ▶ Road Lighting, Industrial Lighting

Product Selection Guide

Model	Power(W)	Output voltage (Vdc)	Full power current adjustable range(A)	Default output range(A)	Typ. Eff.	Typ. PF	Dimensions (L*W*H)mm
X6-042M062-F*	42	32 ~ 62	0.68 ~ 1.05	32 ~ 43V/0.97A	87.0%	0.96	116*64*33
X6-042M120-F	42	50 ~ 120	0.35 ~ 0.70	50 ~ 60V/0.70A	89.0%	0.97	116*64*33
X6-060M062-F	60	32 ~ 62	0.97 ~ 1.30	32 ~ 62V/0.97A	87.0%	0.96	116*64*33
X6-060M120-F	60	50 ~ 120	0.50 ~ 0.94	50 ~ 64V/0.94A	90.0%	0.97	116*64*33
X6-075Y041	75	20 ~ 41	1.83 ~ 2.67	20 ~ 36V/2.10A	88.0%	0.97	129*68*37
X6-075Y062	75	38 ~ 62	1.21 ~ 1.88	38 ~ 53V/1.40A	89.0%	0.96	129*68*37
X6-075Y108	75	54 ~ 108	0.70 ~ 1.05	54 ~ 108V/0.70A	90.0%	0.96	129*68*37
X6-105Y041	105	20 ~ 41	2.56 ~ 3.50	20 ~ 37V/2.80A	90.0%	0.96	154*68*37
X6-105Y062	105	38 ~ 62	1.69 ~ 2.50	38 ~ 50V/2.10A	91.0%	0.97	154*68*37
X6-105Y100	105	50 ~ 100	1.05 ~ 1.40	50 ~ 75V/1.40A	91.0%	0.97	154*68*37
X6-105Y150	105	75 ~ 150	0.70 ~ 1.05	75 ~ 100V/1.05A	92.0%	0.97	154*68*37
X6-150Y041	150	20 ~ 41	3.66 ~ 5.40	20 ~ 35V/4.20A	91.0%	0.97	174*68*37
X6-150Y062	150	38 ~ 62	2.42 ~ 3.60	38 ~ 47V/3.15A	91.0%	0.96	174*68*37
X6-150Y108	150	54 ~ 108	1.39 ~ 2.10	54 ~ 71V/2.10A	91.0%	0.96	174*68*37
X6-150Y143	150	80 ~ 143	1.05 ~ 1.50	80 ~ 143V/1.05A	92.0%	0.97	174*68*37
X6-150Y214	150	107 ~ 214	0.70 ~ 1.05	107 ~ 214V/0.70A	92.0%	0.97	174*68*37
X6-200Y041	200	20 ~ 41	4.88 ~ 6.67	20 ~ 36V/5.56A	91.0%	0.96	194*68*39
X6-200Y062	200	38 ~ 62	3.23 ~ 5.00	38 ~ 41V/4.90A	92.0%	0.97	194*68*39
X6-200Y096	200	48 ~ 96	2.10 ~ 3.00	48 ~ 71V/2.80A	92.0%	0.97	194*68*39
X6-200Y143	200	70 ~ 143	1.40 ~ 2.10	70 ~ 143V/1.40A	93.0%	0.97	194*68*39
X6-200Y191	200	96 ~ 191	1.05 ~ 1.50	96 ~ 190V/1.05A	93.0%	0.97	194*68*39
X6-200Y286	200	143 ~ 286	0.70 ~ 1.05	143 ~ 286V/0.70A	92.0%	0.97	194*68*39
X6-240Y041	240	20 ~ 41	5.86 ~ 7.50	20 ~ 35V/6.70A	92.0%	0.97	209*68*39
X6-240Y062	240	38 ~ 62	3.88 ~ 5.71	38 ~ 48V/5.00A	92.0%	0.97	209*68*39
X6-240Y171	240	85 ~ 171	1.40 ~ 2.10	85 ~ 171V/1.40A	93.0%	0.97	209*68*39
X6-240Y229	240	114 ~ 229	1.05 ~ 1.50	114 ~ 228V/1.05A	93.0%	0.97	209*68*39
X6-240Y343	240	171 ~ 343	0.70 ~ 1.05	171 ~ 343V/0.70A	93.5%	0.97	209*68*39
X6-320Y041Z	320	20 ~ 41	7.80 ~ 10.00	20 ~ 36V/8.90A	92.0%	0.96	231*98*42
X6-320Y062Z	320	38 ~ 62	5.20 ~ 7.50	38 ~ 47V/6.70A	93.0%	0.96	231*98*42
X6-320Y143Z	320	72 ~ 143	2.24 ~ 3.20	72 ~ 114V/2.80A	93.0%	0.96	231*98*42
X6-320Y230Z	320	115 ~ 230	1.39 ~ 2.10	115 ~ 152V/2.10A	92.0%	0.97	231*98*42
X6-320Y457Z	320	228 ~ 457	0.70 ~ 1.10	228 ~ 304V/1.05A	93.0%	0.97	231*98*42

Note:

1. Y=M means 0-5V/0-10V/PWM/Timer dimming, Y=V means non-dimmable, adjustable output current with potentiometer;
2. Suffix *: -F means flicker, no suffix means flicker free;
3. Z=A12, 12V/0.3A auxiliary output; Z=Blank, no auxiliary output.

X7S Series Programmable Intelligent LED Driver



Features

- ▶ Input voltage: 90~305Vac;
- ▶ Isolate constant power design;
- ▶ 3-in-1 dimmable: 0-10V/1-10V/PWM (Dim-to-off optional);
- ▶ 3 Timers dimming: Timing; Virtual Midnight; Self-Adaptive;
- ▶ Constant lumen output(CLO);
- ▶ Off-line programmable;
- ▶ Applicable lamps: Class I & Class II;
- ▶ Surge protection: DM: 6KV, CM: 10KV (Class I);
- ▶ Protections: Input UVP, output SCP / OVP / OTP;
- ▶ Ingress protection rating: IP67;
- ▶ 5 years warranty.



Application

- ▶ Road Lighting , Industrial Lighting

Product Selection Guide

Model	Power(W)	Output voltage (Vdc)	Full power current adjustable range(A)	Default output	Typ. Eff.	Typ. PF	Dimensions (L*W*H)mm
X7S-042M062	42	32 ~ 62	0.68 ~ 1.05	32 ~ 40V/1.05A	89.0%	0.97	122*68*35
X7S-060M062	60	32 ~ 62	0.97 ~ 1.30	32 ~ 57V/1.05A	90.5%	0.97	122*68*35
X7S-075M056	75	28 ~ 56	1.35 ~ 2.15	38 ~ 48V/1.55A	90.5%	0.97	138*68*35
X7S-075M108	75	54 ~ 108	0.70 ~ 1.05	54 ~ 108V/0.70A	91.5%	0.97	138*68*35
X7S-100M056	100	28 ~ 56	1.78 ~ 2.85	38 ~ 48V/2.05A	91.0%	0.97	142*68*37
X7S-100M143	100	72 ~ 143	0.70 ~ 1.05	75 ~ 143V/0.70A	92.0%	0.97	142*68*37
X7S-150M056	150	28 ~ 56	2.70 ~ 4.30	38 ~ 48V/3.10A	92.5%	0.97	160*68*37
X7S-150M214	150	107 ~ 214	0.70 ~ 1.05	107 ~ 214V/0.70A	93.5%	0.97	160*68*37
X7S-200M056	200	28 ~ 56	3.57 ~ 5.70	38 ~ 48V/4.15A	93.0%	0.97	182*68*37
X7S-200M286	200	143 ~ 286	0.70 ~ 1.05	143 ~ 286V/0.70A	94.0%	0.97	182*68*37
X7S-240M056	240	28 ~ 56	4.30 ~ 6.85	38 ~ 48V/5.00A	93.0%	0.97	194*68*37
X7S-240M343	240	171 ~ 343	0.70 ~ 1.05	171 ~ 343V/0.70A	93.5%	0.97	194*68*37
X7S-320M056	320	28 ~ 56	5.70 ~ 9.14	38 ~ 48V/6.70A	94.0%	0.97	244*78*42
X7S-320M457	320	228 ~ 457	0.70 ~ 1.05	228 ~ 457V/0.70A	95.0%	0.97	244*78*42

Note:
M means 0-5V/0-10V/PWM/Timer dimming.

X6S(XCP) Series Class II Programmable Intelligent LED Driver



Features

- ▶ Input voltage: 90 ~ 305Vac;
- ▶ Isolated constant power Class II design;
- ▶ 3-in-1 dimmable: 0-10V/1-10V/PWM (Dim-to-off optional);
- ▶ 3 Timers dimming: Timing; Virtual Midnight; Self-Adaptive;
- ▶ Constant lumen output(CLO);
- ▶ Off-line programmable;
- ▶ (M types) output current adjustable by programmer, (V types) output current adjustable by built-in potentiometer;
- ▶ Surge protection: DM 6KV/4KV(42W-60W);
- ▶ Protections: Output SCP / OVP / OTP;
- ▶ Ingress protection rating: IP67;
- ▶ Suitable for dry / damp / wet locations;
- ▶ Lifetime: 100,000 hours;
- ▶ 5 years warranty.



Application

- ▶ Road Lighting, Industrial Lighting

Product Selection Guide

Model	Power(W)	Output voltage (Vdc)	Full power current adjustable range(A)	Default output	Typ. Eff.	Typ. PF	Dimensions (L*W*H)mm
XCP-042M062*	42	32 ~ 62	0.68 ~ 1.05	32 ~ 43V/0.97A	88.0%	0.97	116*64*33
XCP-060M062*	60	32 ~ 62	0.97 ~ 1.30	32 ~ 62V/0.97A	88.5%	0.97	116*64*33
XCP-075Y041	75	20 ~ 41	1.83 ~ 2.67	20 ~ 36V/2.10A	88.0%	0.97	129*68*37
XCP-075Y062	75	38 ~ 62	1.21 ~ 1.88	38 ~ 53V/1.40A	89.0%	0.97	129*68*37
XCP-075Y108	75	54 ~ 108	0.70 ~ 1.05	54 ~ 108V/0.70A	90.0%	0.97	129*68*37
XCP-105Y041	105	20 ~ 41	2.56 ~ 3.50	20 ~ 37V/2.80A	90.0%	0.97	154*68*37
XCP-105Y062	105	38 ~ 62	1.69 ~ 2.50	38 ~ 50V/2.10A	91.0%	0.97	154*68*37
XCP-105Y150	105	75 ~ 150	0.70 ~ 1.05	75 ~ 100V/1.05A	92.0%	0.97	154*68*37
XCP-150Y041	150	20 ~ 41	3.66 ~ 5.40	20 ~ 35V/4.20A	91.0%	0.97	174*68*37
XCP-150Y062	150	38 ~ 62	2.42 ~ 3.60	38 ~ 47V/3.15A	91.0%	0.97	174*68*37
XCP-150Y214	150	107 ~ 214	0.70 ~ 1.05	107 ~ 214V/0.70A	92.0%	0.97	174*68*37
XCP-200Y062	200	38 ~ 62	3.23 ~ 5.00	38 ~ 47V/4.20A	92.0%	0.97	194*68*39
XCP-200Y286	200	143 ~ 286	0.70 ~ 1.05	143 ~ 286V/0.70A	92.0%	0.97	194*68*39
XCP-240Y041	240	20 ~ 41	5.86 ~ 7.50	20 ~ 36V/6.70A	92.0%	0.97	209*68*39
XCP-240Y062	240	38 ~ 62	3.88 ~ 5.71	38 ~ 48V/5.00A	92.0%	0.97	209*68*39
XCP-240Y343	240	171 ~ 343	0.70 ~ 1.05	171 ~ 228V/1.05A	93.5%	0.97	209*68*39
XCP-320Y062Z	320	38 ~ 62	5.20 ~ 7.50	38 ~ 47V/6.70A	93.0%	0.97	231*98*42
XCP-320Y457Z	320	228 ~ 457	0.70 ~ 1.10	228 ~ 304V/1.05A	93.0%	0.97	231*98*42

Note:

1. Y=M means 0-5V/0-10V/PWM/Timer dimming, Y=V means non-dimmable, adjustable output current with potentiometer;
2. Suffix *: no suffix means flicker free, flicker version optional;
3. Z=A12, 12V/0.3A auxiliary output; Z=Blank, no auxiliary output.

X7E Series Dimmable LED Driver



Features

- ▶ Input voltage: 176~264Vac;
- ▶ Isolate constant current design;
- ▶ The output current is adjustable by built-in potentiometer(Off-line programmable optional);
- ▶ 3-in-1 dimmable: 0/1~10Vdc / PWM/ Resistor dimming;
- ▶ Output and Dimming Signal Isolating;
- ▶ Surge protection: 4KV DM, 6KV CM(Class I) (15-75W);
6KV DM, 6KV CM(Class I) (100-240W);
- ▶ Applicable lamps: Class I & Class II;
- ▶ Protections: Input UVP, output SCP / OVP / OTP;
- ▶ Suitable for dry / damp / wet locations;
- ▶ 5 years warranty;



Application

- ▶ Road Lighting , Industrial Lighting

Product Selection Guide

Model	Power(W)	Output voltage range(Vdc)	Adjustable output current range(A)	Default output	Typ. Eff.	Typ. PF	Dimensions (L*W*H)mm
X7E-015M060F	15	28~60	0.25~0.40	28~50V/0.30A	87.0%	0.97	102*50*34
X7E-026M058F	26	28~58	0.45~0.62	28~52V/0.50A	88.0%	0.97	102*50*34
X7E-036M058F	36	28~58	0.62~0.80	28~51V/0.70A	89.0%	0.97	114*50*34
X7E-050M058F	50	28~58	0.86~1.20	28~42V/1.20A	89.0%	0.97	115*64*34
X7E-075M058F	75	28~58	1.30~1.60	28~47V/1.60A	90.0%	0.97	115*64*34
X7E-100M143	100	72~143	0.70~1.05	72~133V/0.75A	91.5%	0.97	148*50*34
X7E-150M214	150	115~214	0.70~1.05	115~190V/0.79A	91.5%	0.97	175*53*37
X7E-200M286	200	156~286	0.70~1.05	156~190V/1.05A	93.5%	0.97	196*53*37
X7E-240M343	240	171~343	0.70~1.05	171~229V/1.05A	93.5%	0.97	216*53*37

Note:

1. M means 0-10V/PWM dimming, adjustable output current with potentiometer;
2. F means flicker;
3. X7E-015M060F: CCC-certified only, applicable lamps: Class I.

X6E Programmable Intelligent LED Driver



Features

- ▶ Input voltage: 90 ~ 305Vac;
- ▶ Full power working voltage: 176 ~ 305Vac ;
- ▶ Isolated constant power design;
- ▶ 3-in-1 dimmable: 0-10V/1-10V/PWM (Dim-to-off optional);
- ▶ Timers dimming; Reverse dimming optional;
- ▶ 3 Timers dimming: Timing; Virtual Midnight; Self-Adaptive;
- ▶ Constant lumen output(CLO);
- ▶ Off-line programmable;
- ▶ (M types) output current adjustable by programmer, (V types) output current adjustable by built-in potentiometer;
- ▶ Surge protection: DM 6KV, CM 10KV;
- ▶ Protections: Input UVP, output SCP / OVP / OTP;
- ▶ Ingress protection rating: IP67;
- ▶ Suitable for dry / damp / wet locations;
- ▶ 5 years warranty.



Application

- ▶ Road Lighting, Industrial Lighting

Product Selection Guide

Model	Power(W)	Output voltage (Vdc)	Full power current adjustable range(A)	Default output	Typ. Eff.	Typ. PF	Dimensions (L*W*H)mm
X6E-075Y056	75	28 ~ 56	1.35 ~ 2.15	28 ~ 48V/1.55A	89.0%	0.97	132*68*35
X6E-075Y075	75	42 ~ 75	1.00 ~ 1.50	42 ~ 50V/1.50A	90.5%	0.97	128*68*37
X6E-075Y108	75	54 ~ 108	0.70 ~ 1.05	54 ~ 72V/1.05A	91.0%	0.97	128*68*37
X6E-100Y056	100	28 ~ 56	1.78 ~ 2.85	28 ~ 48V/2.05A	89.0%	0.97	138*68*35
X6E-100Y100	100	56 ~ 100	1.00 ~ 1.50	56 ~ 67V/1.50A	91.5%	0.97	133*68*37
X6E-100Y143	100	72 ~ 143	0.70 ~ 1.05	72 ~ 96V/1.05A	91.5%	0.97	133*68*37
X6E-150Y056	150	28 ~ 56	2.70 ~ 4.30	28 ~ 48V/3.10A	90.0%	0.97	171*68*37
X6E-150Y150	150	85 ~ 150	1.00 ~ 1.50	85 ~ 100V/1.50A	91.5%	0.97	158*68*39
X6E-150Y214	150	115 ~ 214	0.70 ~ 1.05	115 ~ 143V/1.05A	91.5%	0.97	158*68*39
X6E-200Y056	200	28 ~ 56	3.57 ~ 5.70	28 ~ 48V/4.15A	92.0%	0.97	197*68*37
X6E-200Y200	200	120 ~ 200	1.00 ~ 1.50	120 ~ 133V/1.50A	92.0%	0.97	174*68*39
X6E-200Y286	200	156 ~ 286	0.70 ~ 1.05	156 ~ 190V/1.05A	93.0%	0.97	174*68*39
X6E-240Y056	240	28 ~ 56	4.30 ~ 6.85	28 ~ 48V/5.00A	92.5%	0.97	207*68*37
X6E-240Y240	240	130 ~ 240	1.00 ~ 1.50	130 ~ 160V/1.50A	93.0%	0.97	194*68*39
X6E-240Y343	240	171 ~ 343	0.70 ~ 1.05	171 ~ 228V/1.05A	93.0%	0.97	194*68*39

Note:

1. Y=M means 0-5V/0-10V/PWM/Timer dimming;
2. Y=V means non-dimmable, adjustable output current with potentiometer.

X8 Series DALI-2&D4i Intelligent LED Driver



Features

- ▶ Input voltage: 90~305Vac;
- ▶ Isolated constant power design;
- ▶ Applicable lamps: Class I & Class II;
- ▶ DALI2&D4i; Support Part 150(Auxiliary power supply), Part 250(Integrated Power Supply), Part 251(Luminaire data), 252(Energy data), 253(Diagnostics data);
- ▶ 3 Timers dimming: Timing; Virtual Midnight; Self-Adaptive;
- ▶ Constant lumen output(CLO);
- ▶ Auxiliary output: 24V/0.125A, built-in 16V bus power supply;
- ▶ Standby power consumption<0.5W;
- ▶ NFC programmable;
- ▶ Surge protection: 6KV DM, 10KV CM (Class I);
- ▶ Protection: External NTC(optional); Input UVP / OVP, Output SCP / OVP / OTP;
- ▶ Ingress protection rating: IP67;
- ▶ Suitable for dry / damp / wet locations;
- ▶ 7 years warranty.

Application

- ▶ Road Lighting , Industrial Lighting

Product Selection Guide

Model	Power(W)	Output voltage range(Vdc)	Full power output current range(A)	Default output	Typ. Eff.	Typ. PF	Dimensions (L*W*H)mm
X8-042D062	42	32 ~ 62	0.68 ~ 1.05	32 ~ 40V/1.05A	88.5%	0.97	138*72*37
X8-060D062	60	32 ~ 62	0.97 ~ 1.30	32 ~ 57V/1.05A	89.0%	0.97	138*72*37
X8-075D056	75	28 ~ 56	1.35 ~ 2.15	38 ~ 48V/1.55A	90.5%	0.97	155*72*37
X8-075D108	75	54 ~ 108	0.70 ~ 1.05	54 ~ 108V/0.70A	91.0%	0.97	155*72*37
X8-100D056	100	28 ~ 56	1.78 ~ 2.85	38 ~ 48V/2.05A	90.5%	0.97	155*72*37
X8-100D143	100	72 ~ 143	0.70 ~ 1.05	75 ~ 143V/0.70A	91.5%	0.97	155*72*37
X8-150D056	150	28 ~ 56	2.70 ~ 4.30	38 ~ 48V/3.10A	92.0%	0.97	190*72*39
X8-150D214	150	107 ~ 214	0.70 ~ 1.05	107 ~ 214V/0.70A	93.5%	0.97	190*72*39
X8-200D056	200	28 ~ 56	3.57 ~ 5.70	38 ~ 48V/4.15A	93.0%	0.97	190*72*39
X8-200D286	200	143 ~ 286	0.70 ~ 1.05	143 ~ 286V/0.70A	94.0%	0.97	190*72*39
X8-240D056	240	28 ~ 56	4.30 ~ 6.85	38 ~ 48V/5.00A	93.0%	0.97	214*72*39
X8-240D343	240	171 ~ 343	0.70 ~ 1.05	171 ~ 343V/0.70A	94.0%	0.97	214*72*39
X8-320D056	320	28 ~ 56	5.70 ~ 9.14	38 ~ 48V/6.70A	93.5%	0.97	248*72*39
X8-320D457	320	228 ~ 457	0.70 ~ 1.05	228 ~ 457V/0.70A	94.0%	0.97	248*72*39

Note:
D means DALI-2 & Timer dimming.

X6E Series DALI-2 Programmable Intelligent LED Driver



Features

- ▶ Input voltage: 90 ~ 305Vac;
- ▶ Full power working voltage: 176 ~ 305Vac;
- ▶ Isolated constant power design;
- ▶ Dimmable: DALI-2& Timers dimming; Dim-to-off;
- ▶ 3 Timers dimming: Timing; Virtual Midnight; Self-Adaptive;
- ▶ Output current NFC adjustable;
- ▶ Constant lumen output(CLO);
- ▶ Standby power consumption<0.5W;
- ▶ Surge protection: DM 6KV, CM 10KV;
- ▶ Protections: Output SCP / OVP / OTP;
- ▶ Ingress protection rating: IP67;
- ▶ Suitable for dry / damp / wet locations;
- ▶ 5 years warranty.



Application

- ▶ Road Lighting, Industrial Lighting

Product Selection Guide

Model	Power(W)	Output voltage (Vdc)	Full power current adjustable range(A)	Default output	Typ. Eff.	Typ. PF	Dimensions (L*W*H)mm
X6E-075D056	75	28 ~ 56	1.35 ~ 2.15	28 ~ 52V/1.45A	88.0%	0.97	149*72*37
X6E-075D108	75	54 ~ 108	0.70 ~ 1.05	54 ~ 108V/0.70A	90.0%	0.96	149*72*37
X6E-100D056	100	28 ~ 56	1.78 ~ 2.85	28 ~ 49V/2.05A	89.0%	0.97	149*72*37
X6E-100D143	100	72 ~ 143	0.70 ~ 1.05	72 ~ 143V/0.70A	90.0%	0.96	149*72*37
X6E-150D056	150	28 ~ 56	2.70 ~ 4.30	28 ~ 48V/3.10A	89.0%	0.97	178*72*39
X6E-150D214	150	107 ~ 214	0.70 ~ 1.05	107 ~ 214V/0.70A	91.0%	0.97	178*72*39
X6E-200D056	200	28 ~ 56	3.57 ~ 5.70	28 ~ 48V/4.15A	91.0%	0.97	199*72*39
X6E-200D286	200	143 ~ 286	0.70 ~ 1.05	143 ~ 286V/0.70A	92.0%	0.97	199*72*39
X6E-240D056	240	28 ~ 56	4.30 ~ 6.85	28 ~ 56V/4.30A	93.0%	0.97	214*72*39
X6E-240D343	240	171 ~ 343	0.70 ~ 1.05	171 ~ 343V/0.70A	93.0%	0.97	209*72*39

Note:
D means DALI-2 & Timer dimming.

X7A Auxiliary Source Series Intelligent LED Driver



Features

- ▶ Input voltage: 90 ~ 305Vac;
- ▶ Isolated constant power design;
- ▶ 3-in-1 dimmable: 0-10V/PWM/Res. ; Dim-to-off;
- ▶ Output current NFC adjustable;
- ▶ Standby power consumption<0.5W;
- ▶ Auxiliary output: 12V/0.25A;
- ▶ Surge protection: DM 6KV, CM 10KV;
- ▶ Protections: Output SCP / OVP / OTP;
- ▶ Ingress protection rating: IP67;
- ▶ Suitable for dry / damp / wet locations;
- ▶ 5 years warranty.

Class P

Application

- ▶ Road Lighting, Industrial Lighting and Horticulture Lighting

Product Selection Guide

Model	Power(W)	Output voltage (Vdc)	Full power current adjustable range(A)	Default output	Typ. Eff.	Typ. PF	Dimensions (L*W*H)mm
X7-075M056A12	75	28 ~ 56	1.35 ~ 2.15	28 ~ 52V/1.45A	89.0%	0.97	147*72*37
X7-075M108A12	75	54 ~ 108	0.70 ~ 1.05	54 ~ 108V/0.70A	89.0%	0.97	147*72*37
X7-100M056A12	100	28 ~ 56	1.78 ~ 2.85	28 ~ 49V/2.05A	90.0%	0.97	160*72*37
X7-100M143A12	100	72 ~ 143	0.70 ~ 1.05	72 ~ 143V/0.70A	90.0%	0.97	160*72*37
X7-150M056A12	150	28 ~ 56	2.70 ~ 4.30	28 ~ 48V/3.10A	91.0%	0.97	183*72*37
X7-150M214A12	150	107 ~ 214	0.70 ~ 1.05	107 ~ 214V/0.70A	91.0%	0.97	183*72*37
X7-200M056A12	200	28 ~ 56	3.57 ~ 5.70	28 ~ 48V/4.15A	91.0%	0.97	199*72*39
X7-200M286A12	200	143 ~ 286	0.70 ~ 1.05	143 ~ 286V/0.70A	93.0%	0.97	199*72*39
X7-240M056A12	240	28 ~ 56	4.30 ~ 6.85	28 ~ 48V/5.00A	92.0%	0.97	231*72*39
X7-240M343A12	240	171 ~ 343	0.70 ~ 1.05	171 ~ 343V/0.70A	93.0%	0.97	222*72*39

Note:

1. Y=M means 0-10V/PWM/Res. dimming;
2. Z=A12, 12V/0.25A auxiliary output.

U7+ Series DALI-2&D4i Intelligent LED Driver



Features

- ▶ Input voltage: 176 ~ 305Vac;
- ▶ Isolated constant power design;
- ▶ External NTC;
- ▶ DALI-2&D4i, Support Part 150(Auxiliary power supply), Part 250(Integrated Power Supply), Part 251(Luminaire data), 252(Energy data), 253(Diagnostics data);
- ▶ 3 Timers dimming: Timing; Virtual Midnight; Self-Adaptive;
- ▶ AC dimming;
- ▶ Constant lumen output(CLO);
- ▶ NFC programmable;
- ▶ Auxiliary output: 24V/0.125A, built-in 16V bus power supply;
- ▶ Applicable lamps: Class I & Class II;
- ▶ Surge protection: DM 6KV, CM 10KV(Class I);
- ▶ Protections: Input OVP / UVP, output SCP / OVP / OTP;
- ▶ High lifetime: 50K hours ~ 100K hours;
- ▶ Ingress protection rating: IP20;
- ▶ Suitable for dry / damp / wet locations;
- ▶ 5-7 years warranty.

Application

- ▶ Road Lighting, Urban Public Lighting

Product Selection Guide

Model	Power(W)	Output voltage (Vdc)	Full power current adjustable range(A)	Default output	Typ. Eff.	Typ. PF	Dimensions (L*W*H)mm
U7-022D072+	22	24 ~ 72	0.30 ~ 0.50	24 ~ 44V/0.50A	86.0%	0.95	133*77*40
U7-026D038+	26	20 ~ 38	0.70 ~ 1.05	20 ~ 38V/0.70A	86.0%	0.95	133*77*40
U7-032D112+	32	45 ~ 112	0.30 ~ 0.50	45 ~ 64V/0.50A	86.0%	0.95	133*77*40
U7-040D057+	40	28 ~ 57	0.70 ~ 1.05	28 ~ 57V/0.70A	88.0%	0.98	133*77*40
U7-060D086+	60	38 ~ 86	0.70 ~ 1.05	38 ~ 86V/0.70A	89.0%	0.98	133*77*40
U7-060D200+	60	78 ~ 200	0.30 ~ 0.50	78 ~ 120V/0.50A	89.0%	0.98	133*77*40
U7-080D115+	80	35 ~ 115	0.70 ~ 1.05	35 ~ 115V/0.70A	91.0%	0.97	133*77*40
U7-080D272+	80	115 ~ 272	0.30 ~ 0.50	115 ~ 160V/0.50A	91.0%	0.97	133*77*40
U7-120D172+	120	75 ~ 172	0.70 ~ 1.05	75 ~ 172V/0.70A	92.0%	0.97	133*77*40
U7-120D320+	120	160 ~ 320	0.30 ~ 0.50	160 ~ 171V/0.50A	92.0%	0.97	133*77*40
U7-165D236+	165	115 ~ 236	0.70 ~ 1.05	115 ~ 236V/0.70A	93.0%	0.97	171*101*41
U7-200D286+	200	143 ~ 286	0.70 ~ 1.05	143 ~ 286V/0.70A	93.0%	0.97	171*101*41

Note:
D means DALI-2 & Timer dimming.

U5 Series DALI-2 Programmable Intelligent LED Driver



Features

- ▶ Input voltage: 176 ~ 305Vac;
- ▶ Isolated constant power design;
- ▶ DALI-2 certified, Support Part 251(Luminaire data), 252 (Energy data), 253 (Diagnostics data);
- ▶ 3 Timers dimming: Timing; Virtual Midnight; Self-Adaptive;
- ▶ Constant lumen output(CLO);
- ▶ NFC programmable;
- ▶ (D types) Adjust output current (AOC) by NFC or DALI-2 programmer;
- ▶ (V types) output current adjustable by built-in potentiometer;
- ▶ (M types) output current adjustable by programmer;
- ▶ Standby power consumption<0.5W;
- ▶ Applicable lamps: Class I & Class II;
- ▶ Surge protection: DM 6KV, CM 10KV (Class I);
- ▶ Protections: Input UVP, output SCP / OVP / OTP;
- ▶ Ingress protection rating: IP20;
- ▶ 5-7 years warranty.

Application

- ▶ Road Lighting, Urban Public Lighting

Product Selection Guide

Model	Power(W)	Output voltage (Vdc)	Full power current adjustable range(A)	Default output	Typ. Eff.	Typ. PF	Dimensions (L*W*H)mm
U5-026Y048	26	20 ~ 48	0.55 ~ 1.05	20 ~ 37V/0.70A	89.0%	0.97	133*77*40
U5-040Y060	40	28 ~ 60	0.67 ~ 1.05	28 ~ 57V/0.70A	91.0%	0.97	133*77*40
U5-060Y090	60	38 ~ 90	0.67 ~ 1.05	38 ~ 86V/0.70A	90.0%	0.97	133*77*40
U5-080Y120	80	35 ~ 120	0.67 ~ 1.05	35 ~ 114V/0.70A	90.5%	0.97	133*77*40
U5-120Y220	120	75 ~ 220	0.55 ~ 1.05	75 ~ 171V/0.70A	91.5%	0.98	133*77*40
U5-165Y270	165	115 ~ 270	0.62 ~ 1.05	115 ~ 236V/0.70A	94.0%	0.97	171*101*41
U5-200Y300	200	143 ~ 300	0.67 ~ 1.05	143 ~ 286V/0.70A	94.0%	0.97	171*101*41

Note:

1. Y=D means DALI-2 & Timer dimming;
2. Y=M means 0-10V/PWM/Timer dimming (only for 40/80/120/165W);
3. Y=V means non-dimmable, adjustable output current with potentiometer.

U6M Series off-line Programmable Intelligent LED Driver



Features

- ▶ Input voltage: 176 ~ 264Vac;
- ▶ Isolated constant power design;
- ▶ Dimmable: 3-in-1 dimmable: 0-10V/1-10V/PWM (Dim-to-off optional);
- ▶ 3 Timers dimming: Timing; Virtual Midnight; Self-Adaptive;
- ▶ Constant lumen output(CLO);
- ▶ NFC programmable;
- ▶ Applicable lamps: Class I & Class II;
- ▶ Surge protection: DM 6KV, CM 10KV(Class I);
- ▶ Protections: Input UVP / OVP, output SCP / OVP / OTP;
- ▶ Zhaga interface: Book 13;
- ▶ Ingress protection rating: IP20;
- ▶ Suitable for dry / damp / wet locations;
- ▶ 5-7 years warranty.

Application

- ▶ Road Lighting , Urban Public Lighting

Product Selection Guide

Model	Power(W)	Output voltage (Vdc)	current adjustable range(A)	Default output	Typ. Eff.	Typ. PF	Dimensions (L*W*H)mm
U6-026M048	26	20 ~ 48	0.55 ~ 1.05	20 ~ 48V/0.70A	89.0%	0.97	133*77*40
U6-040M060	40	28 ~ 60	0.67 ~ 1.05	28 ~ 60V/0.70A	90.0%	0.97	133*77*40
U6-060M090	60	38 ~ 90	0.67 ~ 1.05	38 ~ 90V/0.70A	90.5%	0.97	133*77*40
U6-080M120	80	35 ~ 120	0.67 ~ 1.05	35 ~ 115V/0.70A	91.5%	0.97	133*77*40
U6-120M220	120	75 ~ 220	0.55 ~ 1.05	75 ~ 220V/0.70A	92.5%	0.98	133*77*40
U6-165M270	165	115 ~ 270	0.62 ~ 1.05	115 ~ 270V/0.70A	93.0%	0.98	171*101*41
U6-200M300	200	143 ~ 300	0.67 ~ 1.05	143 ~ 300V/0.70A	94.0%	0.98	171*101*41

Note:
M means 0-5V/0-10V/PWM dimming

X7P Series PSE Version Programmable Intelligent LED Driver



Features

- ▶ Input voltage: 90 ~ 264Vac;
- ▶ Rated input voltage: 100Vac, 200Vac, 220~240Vac;
- ▶ Isolated constant power design;
- ▶ 3-in-1 dimmable: 0-10V/1-10V/PWM (Dim-to-off optional), Timers dimming; Reverse dimming optional; Dim-to-off;
- ▶ 3 Timers dimming: Timing; Virtual Midnight; Self-Adaptive;
- ▶ Constant lumen output(CLO);
- ▶ Off-line programmable;
- ▶ (M types) offline programmable, (V types) output current adjustable by built-in potentiometer;
- ▶ Surge protection: DM 6KV, CM 15KV(60-200W); DM 4KV, CM15KV(40W);
- ▶ Protections: Input UVP / OVP, output SCP / OVP / OTP;
- ▶ Ingress protection rating: IP68;
- ▶ Suitable for dry / damp / wet locations;
- ▶ 5 years warranty.

Application

- ▶ Ship Lighting, Road Lighting and Industrial Lighting

Product Selection Guide

Model	Power(W)	Output voltage (Vdc)	Full power current adjustable range(A)	Default output	Typ. Eff.	Typ. PF	Dimensions (L*W*H)mm
X7P-040V056	40	32 ~ 56	0.72 ~ 0.80	32 ~ 50V/0.80A	87.0%	0.95	140*55*34
X7P-040M056	40	32 ~ 56	0.72 ~ 0.80	32 ~ 50V/0.80A	87.0%	0.95	140*55*34
X7P-065M062	65	36 ~ 62	1.05 ~ 1.20	36 ~ 60V/1.10A	89.0%	0.97	141*68*37
X7P-105M150	105	72 ~ 150	0.70 ~ 1.20	72 ~ 96V/1.10A	92.0%	0.97	179*68*37
X7P-150M214	150	107 ~ 214	0.70 ~ 1.20	107 ~ 137V/1.10A	92.0%	0.97	199*68*37
X7P-200M286	200	143 ~ 286	0.70 ~ 1.20	143 ~ 182V/1.10A	92.0%	0.97	219*68*37

Note:

Please provide the importer's information prior to the shipment of this product.

X6I Series BIS Version Programmable Intelligent LED Driver



Features

- ▶ Input voltage: 110 ~ 305Vac;
- ▶ Isolated constant power design;
- ▶ 3-in-1 dimmable: 0-10V/1-10V/PWM (Dim-to-off optional), Timers dimming; Dim-to-off;
- ▶ 3 Timers dimming: Timing; Virtual Midnight; Self-Adaptive;
- ▶ Constant lumen output(CLO);
- ▶ Off-line programmable;
- ▶ (M types) offline programmable, (V types) output current adjustable by built-in potentiometer;
- ▶ Surge protection: DM 5KV, CM 10KV;
- ▶ 440Vac Protection: >48hours;
- ▶ Protections: Input OVP, output SCP / OVP / OTP;
- ▶ Ingress protection rating: IP67;
- ▶ Suitable for dry / damp / wet locations;
- ▶ 5 years warranty.

Application

- ▶ Road Lighting, Industrial Lighting

Product Selection Guide

Model	Power(W)	Output voltage (Vdc)	Full power current adjustable range(A)	Default output	Typ. Eff.	Typ. PF	Dimensions (L*W*H)mm
X6I-075Y062	75	38 ~ 62	1.21 ~ 1.88	38 ~ 53V/1.40A	89.0%	0.96	129*68*37
X6I-075Y108	75	54 ~ 108	0.70 ~ 1.05	54 ~ 108V/0.70A	90.0%	0.96	129*68*37
X6I-105Y062	105	38 ~ 62	1.69 ~ 2.50	38 ~ 50V/2.10A	91.0%	0.97	154*68*37
X6I-105Y150	105	75 ~ 150	0.70 ~ 1.05	75 ~ 100V/1.05A	92.0%	0.97	154*68*37
X6I-150Y062	150	38 ~ 62	2.42 ~ 3.60	38 ~ 47V/3.15A	91.0%	0.96	174*68*37
X6I-150Y214	150	107 ~ 214	0.70 ~ 1.05	107 ~ 214V/0.70A	92.0%	0.97	174*68*37
X6I-200Y062	200	38 ~ 62	3.23 ~ 5.00	38 ~ 41V/4.90A	92.0%	0.97	194*68*39
X6I-200Y286	200	143 ~ 286	0.70 ~ 1.05	143 ~ 286V/0.70A	92.0%	0.97	194*68*39
X6I-240Y062	240	38 ~ 62	3.88 ~ 5.71	38 ~ 48V/5.00A	92.0%	0.97	209*68*39
X6I-240Y343	240	171 ~ 343	0.70 ~ 1.05	171 ~ 343V/0.70A	93.5%	0.97	209*68*39
X6I-320Y457	320	228 ~ 457	0.70 ~ 1.10	228 ~ 304V/1.05A	94.0%	0.97	231*98*42

Note:

1. Y=M means 0-5V/0-10V/PWM/Timer dimming;
2. Y=V means non-dimmable, adjustable output current with potentiometer.

X7I Series Isolated Constant Power Intelligent LED Driver



Features

- ▶ Input voltage: 108 ~ 305Vac;
- ▶ Full power working voltage: 140 ~ 305Vac;
- ▶ Isolated constant power design;
- ▶ Output current adjustable by built-in potentiometer;
- ▶ 440Vac Protection: >48hours;
- ▶ Surge protection: DM 6KV, CM 10KV;
- ▶ Protections: Input UVP / OVP, output SCP / OVP / OTP;
- ▶ Ingress protection rating: IP67;
- ▶ Suitable for dry / damp / wet locations;
- ▶ 5 years warranty.



Application

- ▶ Road Lighting, Industrial Lighting

Product Selection Guide

Model	Power(W)	Output voltage (Vdc)	Full power current adjustable range(A)	Default output	Typ. Eff.	Typ. PF	Dimensions (L*W*H)mm
X7I-105V150	105	75 ~ 150	0.70 ~ 1.05	75 ~ 150V/0.70A	90.0%	0.97	134*68*35
X7I-150V214	150	115 ~ 214	0.70 ~ 1.05	115 ~ 214V/0.70A	92.0%	0.97	163*68*37
X7I-200V286	200	156 ~ 286	0.70 ~ 1.05	156 ~ 286V/0.70A	92.5%	0.97	176*68*37
X7I-240V343	240	171 ~ 343	0.70 ~ 1.05	171 ~ 343V/0.70A	92.5%	0.97	189*68*37

X6L Series 3-in-1 Dimming LED Driver



Features

- ▶ Input voltage: 90 ~ 305Vac;
- ▶ Isolated constant current design, flicker free(optional);
- ▶ 3-in-1 dimmable: 0-10V/PWM/Res. ; Reverse dimming optional; Dim-to-off;
- ▶ Output current adjustable by built-in potentiometer;
- ▶ THD<10%;
- ▶ Standby power consumption<0.5W;
- ▶ Surge protection: DM 4KV, CM 6KV;
- ▶ Protections: Output SCP / OVP;
- ▶ Ingress protection rating: IP67;
- ▶ Suitable for dry / damp / wet locations;
- ▶ 5 years warranty.



Application

- ▶ Road Lighting , Industrial Lighting and Landscape Lighting

Product Selection Guide

Model	Power(W)	Output voltage (Vdc)	Adjustable output current range(A)	Default output	Typ. Eff.	Typ. PF	Dimensions (L*W*H)mm
X6-026Y052	26	28 ~ 52	0.25 ~ 0.50	28 ~ 52V/0.50A	88.0%	0.97	119*65*34
X6-036Y052	36	28 ~ 52	0.40 ~ 0.80	28 ~ 45V/0.80A	88.0%	0.97	119*65*34
X6-042Y052	42	28 ~ 52	0.47 ~ 0.94	28 ~ 45V/0.94A	89.0%	0.96	132*65*34
X6-060Y052	60	28 ~ 52	0.67 ~ 1.34	28 ~ 45V/1.20A	89.0%	0.97	132*65*34
X6-026Y052L	26	28 ~ 52	0.25 ~ 0.50	28 ~ 52V/0.50A	87.0%	0.96	119*65*34
X6-026Y086L	26	50 ~ 86	0.23 ~ 0.46	50 ~ 57V/0.46A	91.5%	0.97	119*65*34
X6-036Y052L	36	28 ~ 52	0.70 ~ 0.80	28 ~ 45V/0.80A	88.0%	0.96	119*65*34
X6-042Y052L	42	28 ~ 52	0.80 ~ 0.94	28 ~ 45V/0.94A	88.0%	0.96	119*65*34
X6-042Y086L	42	50 ~ 86	0.37 ~ 0.74	50 ~ 57V/0.74A	91.5%	0.97	119*65*34
X6-060Y052L	60	28 ~ 52	1.15 ~ 1.34	28 ~ 45V/1.34A	88.0%	0.96	119*65*34
X6-060Y086L	60	50 ~ 86	0.52 ~ 1.05	50 ~ 57V/1.05A	92.0%	0.97	119*65*34

Note:

1. Y=M means 0-5V/0-10V/PWM/Res. dimming, Y=V means non-dimmable, adjustable output current with potentiometer;
2. L means flicker,no suffix means flicker free.

IOT LED DRIVER



Product Introduction

▶ The intelligent control integrated power supply is a wide-area network communication and intelligent dimming power supply developed specifically for smart streetlights. It represents a major industry upgrade for smart streetlight control systems. Under the definition of software platform functions, it provides hardware-software integrated lication solutions for smart streetlights. The product supports strategy-based offline operation, features simple wiring and maintenance, and can be widely applied to LED streetlight fixtures in scenarios such as road lighting, park lighting, port lighting, and scenic area lighting.

Features

- ▶ Input voltage: 90 ~ 305Vac;
- ▶ Control: Remote control, Intelligent strategy, Data collection, Power statistics;
- ▶ Network: Automatic networking, Wireless dual mode*, Quick response, Remote OTA;
- ▶ Alarm: Fault alarm, Power-off alarm, Tilt alarm*, Light-out alarm;
- ▶ Value-added: Edge computing, Motion sensing*, Protocol customization*, Free traffic;
- ▶ Surge protection: DM 6KV, CM 10KV;
- ▶ Protection: Input UVP/OVP, output SCP / OVP / OTP.

Application

- ▶ Road Lighting , Industrial Lighting and Landscape Lighting

Product Selection Guide

Model	Power(W)	Output voltage range(Vdc)	Adjustable output current range(A)	Communication mode	Typ. Eff.	Typ. PF	Dimensions (L*W*H)mm
I6-075C056	75	28 ~ 56	1.35 ~ 2.15	4G Cat.1	90.0%	0.97	167*37*68
I6-075C108	75	54 ~ 108	0.70 ~ 1.05		89.5%	0.97	181*37*68
I6-100C056	100	28 ~ 56	1.80 ~ 2.85		90.0%	0.97	177*37*68
I6-100C143	100	72 ~ 143	0.70 ~ 1.05		91.0%	0.97	181*37*68
I6-150C056	150	28 ~ 56	2.70 ~ 4.30		92.0%	0.97	200*37*68
I6-150C214	150	107 ~ 214	0.70 ~ 1.05		92.5%	0.97	195*37*68
I6-200C056	200	28 ~ 56	3.57 ~ 5.70		92.0%	0.97	215*37*68
I6-200C286	200	143 ~ 286	0.70 ~ 1.05		93.5%	0.97	225*37*68
I6-240C056	240	28 ~ 56	4.30 ~ 6.30		93.0%	0.97	232*37*68
I6-240C343	240	171 ~ 343	0.70 ~ 1.05		93.5%	0.97	225*37*68

Note:
*Optional functions



G6T-(III) Series 

G6T-(II) Series

G6D-(II) Series

G6C-(II) Series

G6H Series

A5(MEP) Series

N6H Series

N7-(II) Series 

N7 Series

N7L-(II) Series 

N7L Series

N7C Series

N5 Series 

N6(MNC) Series

Industrial Lighting LED Driver

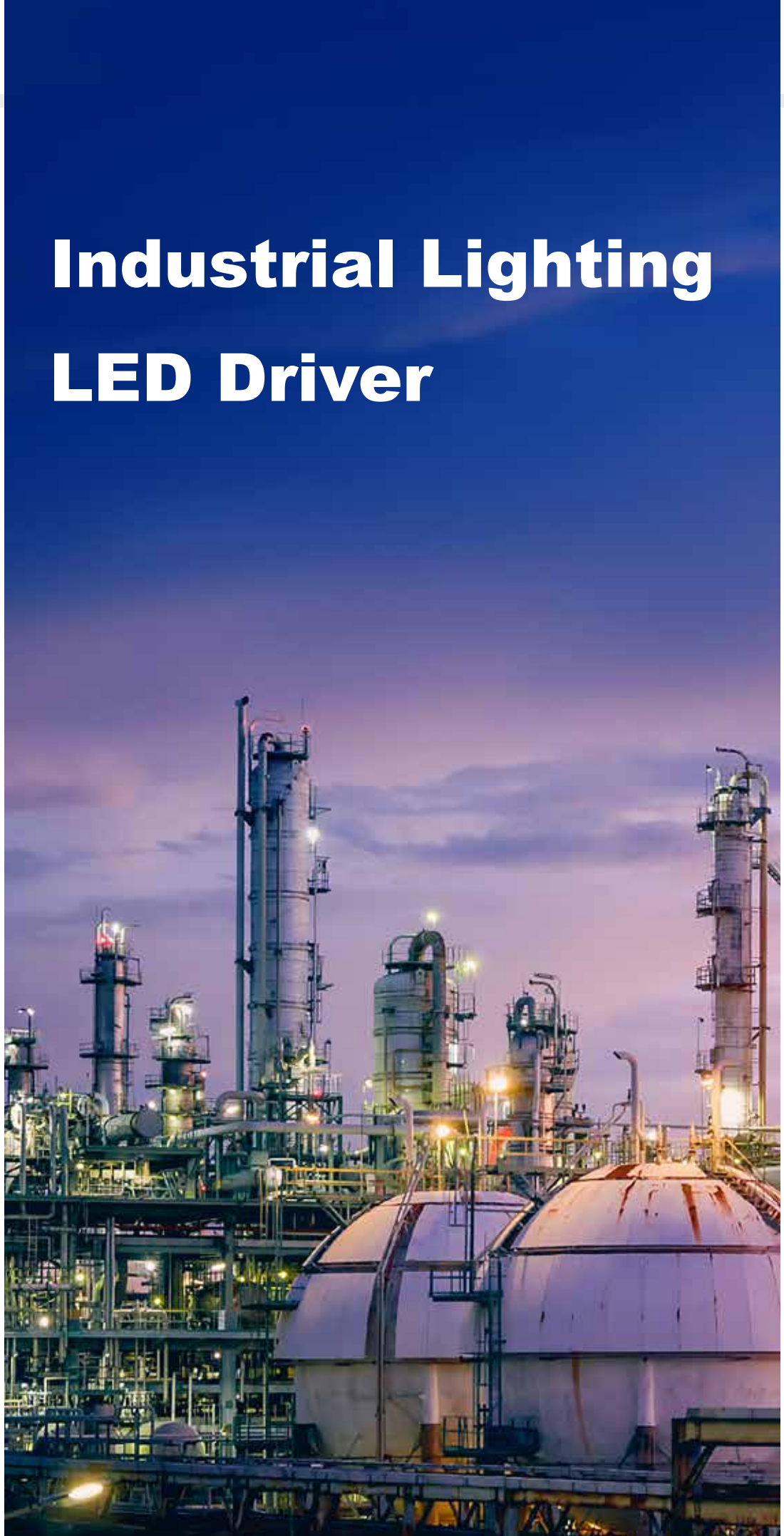

G6T-(III) Series Non-isolated Intelligent LED Driver



Features

- ▶ Input voltage: 90 ~ 305Vac;
- ▶ Non-isolated constant current design;
- ▶ 3-in-1 dimmable: 0-10V/PWM/Res., Dim-to-off;
- ▶ Auxiliary output: 12V/0.2A (optional);
- ▶ Standby power consumption < 0.5W;
- ▶ Off-line programmable, Dip switch adjustable power and color temperature (optional);
- ▶ Surge protection: DM 6KV, CM 6KV;
- ▶ Protections: Output SCP / OVP / OTP;
- ▶ Ingress protection rating: IP65;
- ▶ 5 years warranty.

Application

- ▶ Industrial Lighting.

Product Selection Guide

Model	Power(W)	Output voltage range(Vdc)	Adjustable output current range(A)	Typ. Eff.	Typ. PF	Dimensions (φ*H)mm
G6-050Y300ZT(III)	50	180 ~ 300	0.05 ~ 0.25	95.0%	0.97	127*59
G6-100Y300ZT(III)	100	180 ~ 300	0.10 ~ 0.50	97.0%	0.97	127*59
G6-150Y300ZT(III)	150	180 ~ 300	0.15 ~ 0.74	97.0%	0.97	127*59
G6-200Y300ZT(III)	200	180 ~ 300	0.20 ~ 0.93	97.0%	0.97	127*59
G6-240Y300ZT(III)	240	180 ~ 300	0.22 ~ 1.10	97.0%	0.97	127*59
G6-050V300TE(III)	50	180 ~ 300	0.13 ~ 0.25	95.0%	0.97	127*59
G6-120V300TE(III)	120	180 ~ 300	0.30 ~ 0.56	96.0%	0.97	127*59
G6-150V300TE(III)	150	180 ~ 300	0.40 ~ 0.74	96.0%	0.97	127*59
G6-200V300TE(III)	200	180 ~ 300	0.50 ~ 0.93	96.0%	0.97	127*59
G6-240V300TE(III)	240	180 ~ 300	0.60 ~ 1.10	97.0%	0.97	127*59

Note:

1. Y=V&Z=Blank, means non-dimmable;
2. Y=M&Z=A12, 12V/0.2A auxiliary output, 0-10V/PWM/Res. dimming;
3. The suffix "TE" indicates automatic output power derating at 90-176Vac input voltage.

G6T- (II) Series Non-isolated Intelligent LED Driver



Features

- ▶ Input voltage: 90 ~ 305Vac;
- ▶ Non-isolated constant current design;
- ▶ 3-in-1 dimmable: 0-10V/PWM/Res. ;
- ▶ No glow after Dim-to-off (optional);
- ▶ Electronic focus adjustment function (optional);
- ▶ Auxiliary output: 12V/0.2A (optional);
- ▶ Standby power consumption<0.5W;
- ▶ Dip switch adjustable power and color temperature (optional);
- ▶ Surge protection: DM 6KV, CM 6KV;
- ▶ Protections: Output SCP / OVP / OTP;
- ▶ Ingress protection rating: IP65;
- ▶ 5 years warranty.

SAA FC 

Class P    

Application

- ▶ Industrial Lighting

Product Selection Guide

Model	Power(W)	Output voltage range(Vdc)	Adjustable output current range(A)	Typ. Eff.	Typ. PF	Dimensions (φ*H)mm
G6-080Y260ZT(II)	80	180 ~ 260	0.20 ~ 0.37	94.0%	0.97	127*59
G6-120Y260ZT(II)	120	180 ~ 260	0.30 ~ 0.56	95.0%	0.97	127*59
G6-160Y260ZT(II)	160	180 ~ 260	0.40 ~ 0.74	95.0%	0.97	127*59
G6-200Y260ZT(II)	200	180 ~ 260	0.50 ~ 0.93	95.5%	0.97	127*59
G6-240Y260ZT(II)	240	180 ~ 260	0.60 ~ 1.10	96.0%	0.97	127*59
G6-320Y260ZT(II)	320	180 ~ 260	0.75 ~ 1.50	96.0%	0.97	146*62
G6-500Y260ZT(II)	500	180 ~ 260	1.30 ~ 2.35	96.0%	0.97	178*66

Note:

1. Y=M means 1-10V/PWM/Res. dimming, Y=V means non-dimmable;
2. Z=A12, 12V/0.2A auxiliary output, 0-10V/PWM/Res. dimming; Z=Blank, no auxiliary output.

G6D-(II) Series DALI-2/D4i Intelligent LED Driver



Features

- ▶ Input voltage: 90 ~ 305Vac;
- ▶ Non-isolated constant current design;
- ▶ Dimmable: DALI-2/D4I& Timers dimming; No glow after Dim-to-off;
- ▶ Auxiliary output: 24V/0.125A, built-in 16V bus power supply;
- ▶ Standby power consumption<0.5W;
- ▶ Dip switch adjustable power and color temperature (optional);
- ▶ Output current adjustable by DALI programmer;
- ▶ Surge protection: DM 6KV, CM 6KV;
- ▶ Protections: Input UVP / OVP, output SCP / OVP / OTP;
- ▶ Ingress protection rating: IP65;
- ▶ 5 years warranty.

Application

- ▶ Industrial Lighting

Product Selection Guide

Model	Power(W)	Output voltage range(Vdc)	Full power output current range(A)	Typ. Eff.	Typ. PF	Dimensions (φ*H)mm
G6-080D260H(II)	80	180 ~ 260	0.31 ~ 0.37	94.0%	0.97	127*59
G6-120D260H(II)	120	180 ~ 260	0.46 ~ 0.56	94.0%	0.97	127*59
G6-160D260H(II)	160	180 ~ 260	0.62 ~ 0.74	95.0%	0.97	127*59
G6-200D260H(II)	200	180 ~ 260	0.77 ~ 0.93	95.0%	0.97	127*59
G6-240D260H(II)	240	180 ~ 260	0.92 ~ 1.10	96.0%	0.97	127*59

Note:
G6D(II) support D4i.

G6C-(II) Series Non-isolated Intelligent LED Driver



Features

- ▶ Input voltage: 108 ~ 380Vac;
- ▶ Non-isolated constant current design;
- ▶ 3-in-1 dimmable: 0-10V/PWM/Res. , Dim-to-off;
- ▶ Auxiliary output: 12V/0.2A;
- ▶ Dip switch adjustable power and color temperature (optional);
- ▶ Surge protection: DM 6KV, CM 6KV;
- ▶ Protections: Output SCP / OVP / OTP;
- ▶ Ingress protection rating: IP65;
- ▶ 5 years warranty.

Class P   

Application

- ▶ Industrial Lighting

Product Selection Guide

Model	Power(W)	Output voltage range(Vdc)	Adjustable output current range(A)	Typ. Eff.	Typ. PF	Dimensions (φ*H)mm
G6C-120M260A12(II)	120	180 ~ 260	0.30 ~ 0.56	94.0%	0.97	127*59
G6C-160M260A12(II)	160	180 ~ 260	0.40 ~ 0.74	95.0%	0.97	127*59
G6C-200M260A12(II)	200	180 ~ 260	0.50 ~ 0.93	95.0%	0.97	127*59
G6C-240M260A12(II)	240	180 ~ 260	0.60 ~ 1.10	95.0%	0.97	127*59
G6C-320M260A12(II)	320	180 ~ 260	0.80 ~ 1.48	96.0%	0.97	146*62

G6H Series Non-isolated Intelligent LED Driver



Features

- ▶ Input voltage: 198 ~ 528Vac;
- ▶ Non-isolated constant current design;
- ▶ 3-in-1 dimmable: 0-10V/PWM/Res. , Dim-to-off;
- ▶ Auxiliary output: 12V/0.2A;
- ▶ Dip switch adjustable power and color temperature (optional);
- ▶ Surge protection: DM 6KV, CM 6KV;
- ▶ Protections: Output SCP / OVP / OTP;
- ▶ Ingress protection rating: IP65;
- ▶ 5 years warranty.

Class P

Application

- ▶ Industrial Lighting

Product Selection Guide

Model	Power(W)	Output voltage range(Vdc)	Adjustable output current range(A)	Typ. Eff.	Typ. PF	Dimensions (φ*H)mm
G6H-120M260A12	120	180 ~ 260	0.30 ~ 0.56	94.0%	0.97	127*59
G6H-160M260A12	160	180 ~ 260	0.40 ~ 0.74	95.0%	0.97	127*59
G6H-200M260A12	200	180 ~ 260	0.50 ~ 0.93	95.0%	0.97	127*59
G6H-240M260A12	240	180 ~ 260	0.60 ~ 1.10	95.0%	0.97	127*59
G6H-320M260A12	320	180 ~ 260	0.80 ~ 1.48	95.0%	0.97	146*62

A5(MEP) Series Explosion-proof Lighting LED Driver



Features

- ▶ Input voltage: 90 ~ 264Vac;
- ▶ Isolated constant current design;
- ▶ 3-in-1 dimmable: 0-10V/PWM/Res. (optional); Dim-to-off;
- ▶ Auxiliary output: 12V/0.2A (optional);
- ▶ Standby power consumption < 0.5W;
- ▶ Potentiometer adjustment (optional);
- ▶ Surge protection: DM 4KV, CM 6KV;
- ▶ Protections: Output SCP / OVP / OTP;
- ▶ Ingress protection rating: IP65;
- ▶ Warranty: 5 years.



Application

- ▶ Industrial Lighting, Explosion-proof Lighting.

Product Selection Guide

Model	Power(W)	Output voltage range(Vdc)	Output current(A)	Typ. Eff.	Dimensions (φ*H)mm	Certification
MEP-040B058	40	30 ~ 58	0.70	87.0%	75*32	CCC/CE/CB/BIS
MEP-040V058	40	30 ~ 58	0.60 ~ 1.20	87.0%	75*32	CCC/CE/CB/TUV
MEP-050B038	50	20 ~ 38	1.40	88.0%	75*32	CCC/CE/CB
MEP-060B043	60	26 ~ 43	1.40	88.0%	92*38	CCC/CE/CB/BIS
MEP-075V057	75	27 ~ 57	1.00 ~ 1.75	90.0%	92*38	CCC/CE/CB/TUV
MEP-080B058	80	30 ~ 58	1.40	89.0%	112*38	CCC/CE/BIS
MEP-120B058	120	30 ~ 58	2.10	89.0%	112*38	CCC/CE/BIS
A5-040M058A12	40	30 ~ 58	0.60 ~ 0.87	87.0%	92*38	CCC/CE
A5-060M043A12H	60	26 ~ 43	1.20 ~ 1.70	88.0%	92*38	CCC/CE
A5-080M058A12	80	30 ~ 58	1.20 ~ 1.70	90.0%	112*38	CCC/CE
A5-120M058A12	120	30 ~ 58	1.80 ~ 2.60	91.0%	112*38	CCC/CE

Note:

1. B means fixed current, no dimming function;
2. V means non-dimmable, adjustable output current with potentiometer;
3. M means 0-10V/PWM/Res. dimming, adjustable output current with potentiometer.

N6H Series Non-isolated Intelligent LED Driver



Features

- ▶ Input voltage: 198 ~ 528Vac;
- ▶ Non-isolated constant current design;
- ▶ 3-in-1 dimmable: 0-10V/PWM/Res. ;
- ▶ No glow after Dim-to-off;
- ▶ Auxiliary output: 12V/0.2A;
- ▶ Output current adjustable by built-in potentiometer;
- ▶ Surge protection: DM 6KV, CM 6KV;
- ▶ Protections: Output SCP / OVP / OTP;
- ▶ Ingress protection rating: IP65;
- ▶ Warranty: 5 years.

Class P

Application

- ▶ Linear high bay light, Flood light, Wall Pack Light, Shoebox light

Product Selection Guide

Model	Power(W)	Output voltage range(Vdc)	Adjustable output current range(A)	Typ. Eff.	Typ. PF	Dimensions (L*W*H)mm
N6H-100M260A12H	100	180 ~ 260	0.30 ~ 0.50	93.0%	0.97	177*68*39
N6H-150M260A12H	150	180 ~ 260	0.37 ~ 0.75	93.0%	0.97	177*68*39
N6H-200M260A12H	200	180 ~ 260	0.50 ~ 0.90	94.0%	0.97	202*68*39
N6H-240M260A12H	240	180 ~ 260	0.60 ~ 1.10	94.0%	0.97	202*68*39
N6H-320M260A12H	320	180 ~ 260	1.10 ~ 1.48	94.0%	0.97	212*68*39

N7-(II) Series Non-isolated Intelligent LED Driver



Features

- ▶ Input voltage: 90 ~ 305Vac;
- ▶ Non-isolated constant current design;
- ▶ 3-in-1 dimmable: 0-10V/1-10V/PWM, Timers dimming;
- ▶ 3 Timers dimming: Timing; Virtual Midnight; Self-Adaptive;
- ▶ Constant lumen output(CLO);
- ▶ Auxiliary output: 12V/0.2A (optional);
- ▶ Standby power consumption<0.5W;
- ▶ Off-line programmable;
- ▶ Surge protection: DM 6KV, CM 10KV;
- ▶ Protections: Output SCP / OVP / OTP;
- ▶ Ingress protection rating: IP67;
- ▶ 5 years warranty.

SAA FC

Class P

Application

- ▶ Linear high bay light, Flood light, Wall Pack Light, Shoebox light, Stadium Lighting

Product Selection Guide

Model	Power(W)	Output voltage range(Vdc)	Adjustable output current range(A)	Typ. Eff.	Typ. PF	Dimensions (L*W*H)mm
N7-080Y300Z(II)	80	180 ~ 300	0.10 ~ 0.37	95.0%	0.97	135*63*34
N7-100Y300Z(II)	100	180 ~ 300	0.12 ~ 0.56	97.0%	0.97	151*63*34
N7-150Y300Z(II)	150	180 ~ 300	0.15 ~ 0.74	97.0%	0.97	151*63*34
N7-200Y300Z(II)	200	180 ~ 300	0.20 ~ 0.93	97.0%	0.97	166*63*34
N7-240Y300Z(II)	240	180 ~ 300	0.22 ~ 1.10	97.0%	0.97	166*63*34
N7-320Y300Z(II)	320	180 ~ 300	0.30 ~ 1.50	97.0%	0.97	207*63*34
N7-400Y300Z(II)	400	180 ~ 300	0.36 ~ 1.80	97.0%	0.97	255*63*34

Note:

1. Y=V&Z=Blank, means non-dimmable;
2. Y=M&Z=A12, 12V/0.2A auxiliary output, 0-10V/PWM/Res. dimming.

N7 Series Non-isolated Intelligent LED Driver



Features

- ▶ Input voltage: 90 ~ 305Vac;
- ▶ Non-isolated constant current design;
- ▶ 3-in-1 dimmable: 0-10V/PWM/Res. ;
- ▶ No glow after Dim-to-off (optional);
- ▶ Auxiliary output: 12V/0.2A (optional);
- ▶ Standby power consumption<0.5W;
- ▶ Output current adjustable by built-in potentiometer;
- ▶ Surge protection: DM 6KV, CM 10KV;
- ▶ Protections: Output SCP / OVP / OTP;
- ▶ Ingress protection rating: IP67;
- ▶ 5 years warranty.

SAA FC

Class P

Application

- ▶ Linear high bay light, Flood light, Wall Pack Light, Shoebox light

Product Selection Guide

Model	Power(W)	Output voltage range(Vdc)	Adjustable output current range(A)	Typ. Eff.	Typ. PF	Dimensions (L*W*H)mm
N7-060Y260Z	60	180 ~ 260	0.19 ~ 0.28	93.5%	0.97	157*56*37
N7-080Y260Z	80	180 ~ 260	0.26 ~ 0.37	94.0%	0.97	157*56*37
N7-120Y260Z	120	180 ~ 260	0.39 ~ 0.56	95.0%	0.97	169*56*37
N7-160Y260Z	160	180 ~ 260	0.52 ~ 0.74	95.0%	0.97	169*56*37
N7-200Y260Z	200	180 ~ 260	0.65 ~ 0.93	95.0%	0.97	204*56*37
N7-240Y260Z	240	180 ~ 260	0.77 ~ 1.11	95.0%	0.97	204*56*37
N7-320Y260Z	320	180 ~ 260	1.04 ~ 1.48	96.0%	0.97	207*68*37

Note:

1. Y=V&Z=Blank, means non-dimmable;
2. Y=M&Z=A12, 12V/0.2A auxiliary output, 0-10V/PWM/Res. dimming.

N7L-(II) Series Non-isolated Intelligent LED Driver



Features

- ▶ Input voltage: 90 ~ 305Vac;
- ▶ Non-isolated constant current design;
- ▶ 3-in-1 dimmable: 0-10V/1-10V/PWM, Timers dimming;
- ▶ 3 Timers dimming: Timing; Virtual Midnight; Self-Adaptive;
- ▶ Constant lumen output(CLO);
- ▶ DIP switch power and photocontrol related settings are programmable;
- ▶ Auxiliary output: 12V/0.2A (optional);
- ▶ Standby power consumption<0.5W;
- ▶ Off-line programmable;
- ▶ Surge protection: DM 6KV, CM 6KV;
- ▶ Protections: Output SCP / OVP / OTP;
- ▶ 5 years warranty.



Application

- ▶ Linear high bay light, Flood light, Wall Pack Light, Shoebox light

Product Selection Guide

Model	Power(W)	Output voltage range(Vdc)	Adjustable output current range(A)	Typ. Eff.	Typ. PF	Dimensions (L*W*H)mm
N7L-080Y300Z(II)	80	180 ~ 300	0.10 ~ 0.37	95.0%	0.97	106*56*33
N7L-100Y300Z(II)	100	180 ~ 300	0.12 ~ 0.56	97.0%	0.97	121*55*33
N7L-150Y300Z(II)	150	180 ~ 300	0.15 ~ 0.74	97.0%	0.97	121*55*33
N7L-200Y300Z(II)	200	180 ~ 300	0.20 ~ 0.93	97.0%	0.97	136*55*33
N7L-240Y300Z(II)	240	180 ~ 300	0.22 ~ 1.10	97.0%	0.97	136*55*33
N7L-320Y300Z(II)	320	180 ~ 300	0.30 ~ 1.50	97.0%	0.97	177*55*33
N7L-400Y300Z(II)	400	180 ~ 300	0.36 ~ 1.80	97.0%	0.97	225*55*33

Note:

1. Y=V&Z=Blank, means non-dimmable;
2. Y=M&Z=A12, 12V/0.2A auxiliary output, 0-10V/PWM/Res. dimming.

N7L Series Non-isolated Intelligent LED Driver



Features

- ▶ Input voltage: 90 ~ 305Vac;
- ▶ Non-isolated constant current design;
- ▶ 3-in-1 dimmable: 0-10V/PWM/Res. ;
- ▶ No glow after Dim-to-off (optional);
- ▶ Auxiliary output: 12V/0.2A (optional);
- ▶ Standby power consumption<0.5W;
- ▶ Output current adjustable by built-in potentiometer;
- ▶ Surge protection: DM 6KV, CM 6KV;
- ▶ Protections: Output SCP / OVP / OTP;
- ▶ 5 years warranty.

SAA FC

Class P

Application

- ▶ Linear high bay light, Flood light, Wall Pack Light, Shoebox light

Product Selection Guide

Model	Power(W)	Output voltage range(Vdc)	Adjustable output current range(A)	Typ. Eff.	Typ. PF	Dimensions (L*W*H)mm
N7L-030Y260	30	180 ~ 260	0.07 ~ 0.17	92.0%	0.97	112*51*34
N7L-065Y260	60	180 ~ 260	0.15 ~ 0.30	93.0%	0.97	112*51*34
N7L-060Y260Z	60	180 ~ 260	0.19 ~ 0.28	93.5%	0.97	147*53*34
N7L-080Y260Z	80	180 ~ 260	0.26 ~ 0.37	94.0%	0.97	147*53*34
N7L-120Y260Z	120	180 ~ 260	0.39 ~ 0.56	95.0%	0.97	159*53*34
N7L-160Y260Z	160	180 ~ 260	0.52 ~ 0.74	95.0%	0.97	159*53*34
N7L-200Y260Z	200	180 ~ 260	0.65 ~ 0.93	95.0%	0.97	192*53*34
N7L-240Y260Z	240	180 ~ 260	0.77 ~ 1.11	95.0%	0.97	192*53*34
N7L-320Y260Z	320	180 ~ 260	1.04 ~ 1.48	96.0%	0.97	197*66*34

Note:

1. Y=V&Z=Blank, means non-dimmable;
2. Y=M&Z=A12, 12V/0.2A auxiliary output, 0-10V/PWM/Res. dimming.

N7C Series Non-isolated Intelligent LED Driver



Features

- ▶ Input voltage: 108 ~ 380Vac;
- ▶ Non-isolated constant current design;
- ▶ 3-in-1 dimmable: 0-10V/PWM/Res. ;
- ▶ No glow after Dim-to-off (optional);
- ▶ Auxiliary output: 12V/0.2A (optional);
- ▶ Output current adjustable by built-in potentiometer;
- ▶ Surge protection: DM 6KV, CM 6KV;
- ▶ Protections: Output SCP / OVP / OTP;
- ▶ 5 years warranty.

Class P  

Application

- ▶ Linear high bay light, Flood light, Wall Pack Light, Shoebox light

Product Selection Guide

Model	Power(W)	Output voltage range(Vdc)	Adjustable output current range(A)	Typ. Eff.	Typ. PF	Dimensions (L*W*H)mm
N7C-060Y260Z	60	180 ~ 260	0.19 ~ 0.28	93.0%	0.97	147*53*34
N7C-080Y260Z	80	180 ~ 260	0.26 ~ 0.37	93.0%	0.97	147*53*34
N7C-120Y260Z	120	180 ~ 260	0.39 ~ 0.56	94.0%	0.97	159*53*34
N7C-160Y260Z	160	180 ~ 260	0.52 ~ 0.74	94.0%	0.97	159*53*34
N7C-200Y260Z	200	180 ~ 260	0.65 ~ 0.93	95.0%	0.97	192*53*34
N7C-240Y260Z	240	180 ~ 260	0.77 ~ 1.11	95.0%	0.97	192*53*34
N7C-320Y260Z	320	180 ~ 260	1.04 ~ 1.48	96.0%	0.97	237*53*34

Note:

1. Y=V&Z=Blank, means non-dimmable;
2. Y=M&Z=A12, 12V/0.2A auxiliary output, 0-10V/PWM/Res. dimming.

N5 Series Non-isolated Intelligent LED Driver



Features

- ▶ Input voltage: 180~265Vac;
- ▶ Non-isolated constant current design;
- ▶ Output current adjustable by built-in potentiometer;
- ▶ Surge protection: DM 6KV, CM 6KV;
- ▶ Protections: Input OVP 400Vac for 1 hour, SCP / OVP/ OTP;
- ▶ Ingress protection rating: IP67;
- ▶ 7 years warranty.



Application

- ▶ Application: Linear high bay light, Flood light, Wall Pack Light, Shoebox light.

Product Selection Guide

Model	Power(W)	Output voltage range(Vdc)	Adjustable output current range(A)	Typ. Eff.	Typ. PF	Dimensions (L*W*H)mm
N5-010V260	10	180 ~ 260	0.045	92.0%	0.95	125*47*26
N5-020V260	20	180 ~ 260	0.05 ~ 0.10	92.5%	0.95	136*47*26
N5-030V260	30	180 ~ 260	0.09 ~ 0.15	93.0%	0.95	146*47*26
N5-045V260	45	180 ~ 260	0.10 ~ 0.22	94.0%	0.95	146*47*26
N5-070V260	70	180 ~ 260	0.20 ~ 0.35	95.0%	0.97	138*58*33
N5-100V260	100	180 ~ 260	0.25 ~ 0.50	95.0%	0.97	138*58*33
N5-150V260	150	180 ~ 260	0.50 ~ 0.75	95.0%	0.97	138*58*33
N5-200V260	200	180 ~ 260	0.65 ~ 0.90	96.0%	0.97	141*58*33
N5-240V260	240	180 ~ 260	0.75 ~ 1.10	96.0%	0.97	141*58*33
N5-300V260	300	180 ~ 260	1.10 ~ 1.50	96.0%	0.97	181*58*33

Note:
V means non-dimmable;

N6(MNC) Series Non-isolated Intelligent LED Driver

Industrial Lighting LED Driver



Features

- ▶ Input voltage: 90 ~ 305Vac;
- ▶ Non-isolated constant current design;
- ▶ 3-in-1 dimmable: 1-10V/PWM/Res. ;
- ▶ Output current adjustable by built-in potentiometer;
- ▶ Surge protection: DM 4KV, CM 6KV;
- ▶ Protections: Output SCP / OVP / OTP;
- ▶ Ingress protection rating: IP65;
- ▶ 5 years warranty.

SAA

Class P

Application

- ▶ Linear high bay light, Flood light, Wall Pack Light, Shoebox light

Product Selection Guide

Model	Power(W)	Output voltage range(Vdc)	Adjustable output current range(A)	Typ. Eff.	Typ. PF	Dimensions (L*W*H)mm
MNC-060Y240	60	170 ~ 240	0.17 ~ 0.32	93.0%	0.97	124*62*31
MNC-100Y240	100	170 ~ 240	0.32 ~ 0.46	94.0%	0.97	138*55*37
MNC-150Y240	150	170 ~ 240	0.50 ~ 0.71	94.0%	0.97	138*55*37
MNC-200Y240	200	170 ~ 240	0.70 ~ 1.10	95.0%	0.97	151*64*42
MNC-240Y240	240	170 ~ 240	0.77 ~ 1.10	95.0%	0.97	183*64*43

Note:

1. Y=M means 1-10V/PWM/Res. dimming; Y=V means non-dimmable;
2. Certifications of MNC-60W CCC/CE/CB/ENEC.

Stadium Lighting LED Driver



S6 600W Series

S6 880W Series

S6 RGBW Series 

S6 1200- 1800W Series 

S7 Series 

N8H Series 

X6 High Power Series

X6H Series



S6 600W Series Stadium Intelligent LED Driver



SAA FC §

Class P

Features

- ▶ Input voltage range: 198~528Vac;
- ▶ Isolated constant current design;
- ▶ DMX512/DALI-2 optional;
- ▶ DMX512 supports RDM control mode & controller address setting;
- ▶ No glow after Dim-to-off;
- ▶ Ultra low ripple: <2%;
- ▶ Inrush current: <40A@480Vac;
- ▶ PF>0.97@100% load;
- ▶ THD<10%@100% load;
- ▶ Surge protection: 6KV DM, 10KV CM;
- ▶ Protections: Input UVP, output SCP / OVP / OTP;
- ▶ Ingress protection rating: IP66, IK08;
- ▶ 5 years warranty.

Application

- ▶ Stadium Lighting

Product Selection Guide

Model	Power(W)	Output voltage range(Vdc)	Full power output current range(A)	Default output	Typ. Eff.	Typ. PF	Dimensions (L*W*H)mm
S6-600D360	600	172 ~ 360	1.67 ~ 3.00	172 ~ 285V/2.10A	94.0%	0.97	335*144*59
S6-600D520	600	260 ~ 520	1.16 ~ 1.88	260 ~ 500V/1.20A	94.5%	0.95	335*144*59
S6-600R360	600	172 ~ 360	1.67 ~ 3.00	172 ~ 285V/2.10A	94.0%	0.97	335*144*59
S6-600R520	600	260 ~ 520	1.16 ~ 1.88	260 ~ 500V/1.20A	94.5%	0.95	335*144*59

Note:

1. D means DALI-2 dimming;
2. R means DMX512 dimming.

S6 880W Series Stadium Intelligent LED Driver



SAA Class P      

Features

- ▶ Input voltage range: 198~528Vac;
- ▶ Non-isolated constant current design;
- ▶ DMX512/DALI-2 Combine (Software Switchable);
- ▶ DMX512 supports RDM control mode & controller address setting;
- ▶ No glow after Dim-to-off;
- ▶ Ultra low ripple: <2%;
- ▶ Inrush current: <35A@400Vac;
- ▶ PF>0.97@100% load;
- ▶ THD<10%@100% load;
- ▶ Surge protection: 10KV DM, 10KV CM;
- ▶ Protections: Input UVP, output SCP / OVP / OTP;
- ▶ Ingress protection rating: IP66, IK08;
- ▶ 5 years warranty.

Application

- ▶ Stadium Lighting

Product Selection Guide

Model	Power(W)	Output voltage range(Vdc)	Full power output current range(A)	Default output	Typ. Eff.	Typ. PF	Dimensions (L*W*H)mm
S6-880D440	880	190 ~ 440	2.00 ~ 3.60	190 ~ 352V/2.50A	96.5%	0.96	400*150*81
S6-880R440	880	190 ~ 440	2.00 ~ 3.60	190 ~ 352V/2.50A	96.5%	0.96	400*150*81

Note:

1. D means DALI-2 dimming;
2. R means DMX512 dimming.

S6 RGBW Series Stadium Intelligent LED Driver

Stadium Lighting LED Driver



Features

- ▶ Input voltage range: 198~528Vac;
- ▶ Non-Isolated constant power design; 4 channels independent output;
- ▶ DMX512&DALI-2 DT8 Combine (Software Switchable);
- ▶ DMX512 supports RDM control mode & controller address setting;
- ▶ DMX512: flashing function with maximum of 44 flashes per second;
- ▶ DALI-2 DT8 supports color & color temperature control (RGBW/ Tunable White) via single-address multi-channel integration;
- ▶ No glow after Dim-to-off;
- ▶ Max remote distance 300 meters;
- ▶ Ultra low ripple: <2%;
- ▶ Inrush current: <35A@400Vac;
- ▶ Efficiency up to 97%; PF>0.97@100% load; THD<10%@100% load;
- ▶ Surge protection: 10KV DM, 10KV CM;
- ▶ Protections: Input UVP, output SCP / OVP/ OPP / OTP;
- ▶ Ingress protection rating: IP66, IK08;
- ▶ 5 years warranty.

Application

- ▶ Stadium Lighting

Product Selection Guide

Model	Input voltage range(Vac)	Channel	Max output power(W)	Output voltage range(Vdc)	Full power output current range(A)	Eff.(Typ.)	PF(Typ.)
S6-1K6Y400	198~528	1	400	160~400	1.00~2.50	97%	0.97
		2	400	160~400	1.00~2.50		
		3	400	160~400	1.00~2.50		
		4	400	160~400	1.00~2.50		
S6-1K2Y400	198~528	1	300	160~400	0.75~1.87	97%	0.97
		2	300	160~400	0.75~1.87		
		3	300	160~400	0.75~1.87		
		4	300	160~400	0.75~1.87		
S6-880Y360	198~528	1	220	80~360	0.61~1.50	97%	0.97
		2	220	80~360	0.61~1.50		
		3	220	80~360	0.61~1.50		
		4	220	80~360	0.61~1.50		

Note:

1. D means DALI-2/RGBW dimming;
2. R means DMX512 dimming.

S6 1200W-1800W Series Stadium Intelligent LED Driver



Features

- ▶ Input voltage range: 198~440Vac;
- ▶ Non-isolated constant current design; 2/3 channels independent output;
- ▶ DMX512/DALI-2 Combine (Software Switchable);
- ▶ DMX512 supports RDM control mode & controller address setting;
- ▶ No glow after Dim-to-off;
- ▶ Ultra low ripple: <2%;
- ▶ Inrush current: <35A@400Vac;
- ▶ PF>0.97@100% load;
- ▶ THD<10%@100% load;
- ▶ Surge protection: 10KV DM, 10KV CM;
- ▶ Protections: Input UVP, output SCP / OVP / OTP;
- ▶ Ingress protection rating: IP66, IK08;
- ▶ 5 years warranty.



Application

- ▶ Stadium Lighting

Product Selection Guide

Model	Power(W)	Output voltage range(Vdc)	Full power output current range(A)	Default output	Typ. Eff.	Typ. PF	Dimensions (L*W*H)mm
S6-1K2D500	1200(600W ×2)	260 ~ 500	(1.2 ~ 1.8A)*2	1.50A*2	97.0%	0.95	500*150*81
S6-1K5D500	1500(500W ×3)	260 ~ 500	(1.0 ~ 1.4A)*3	1.20A*3	97.0%	0.95	500*150*81
S6-1K8D500	1800(600W ×3)	260 ~ 500	(1.2 ~ 1.8A)*3	1.50A*3	97.0%	0.95	500*150*81
S6-1K2R500	1200(600W ×2)	260 ~ 500	(1.2 ~ 1.8A)*2	1.50A*2	97.0%	0.95	500*150*81
S6-1K5R500	1500(500W ×3)	260 ~ 500	(1.0 ~ 1.4A)*3	1.20A*3	97.0%	0.95	500*150*81
S6-1K8R500	1800(600W ×3)	260 ~ 500	(1.2 ~ 1.8A)*3	1.50A*3	97.0%	0.95	500*150*81

Note:

1. D means DALI-2 dimming;
2. R means DMX512 dimming.

S7 Series Stadium Lighting LED Driver

Stadium Lighting LED Driver



Features

- ▶ Input voltage: 180~528Vac;
- ▶ Non-isolated constant power design;
- ▶ NFC Programming;
- ▶ D/R combined version: DALI-2&D4i/DMX512-RDM control switchable by software + 24V/125mA auxiliary output;
- ▶ DALI-2&D4i: built-in 16V bus power supply;
- ▶ DMX512-RDM: flashes up to 44fps;
- ▶ AC Power Metering with High Accuracy up to $\pm 1\%$;
- ▶ Standby power consumption <0.5W;
- ▶ Ultra low ripple:<1%@<3kHz&100% load;
- ▶ Surge protection: DM 10KV, CM 20KV;
- ▶ Protection: Input UVP, output SCP / OVP / OPP / OTP;
- ▶ Ingress protection rating: IP66, IK08;
- ▶ 5 years warranty.

Application

- ▶ Stadium Lighting

Product Selection Guide

Model	Power(W)	Output voltage range(Vdc)	Full power output current range(A)	Default output	Typ. Eff.	Typ. PF	Dimensions (L*W*H)mm
S7-680Y500	680	200 ~ 500	1.36 ~ 2.60	2.60A	97.0%	0.97	335*144*59
S7-880Y500	880	200 ~ 500	1.76 ~ 3.40	3.40A	97.0%	0.97	400*150*81
S7-1K2Y500	1200(600W ×2)	200 ~ 500	(1.20 ~ 2.30)*2	2.30A*2	97.0%	0.97	400*150*81
S7-1K8Y500	1800(600W ×3)	200 ~ 500	(1.20 ~ 2.30)*3	2.30A*3	97.0%	0.97	500*150*81
S7-2K1Y500	2100(700W ×3)	200 ~ 500	(1.40 ~ 2.70)*3	2.70A*3	97.0%	0.97	500*150*81

Note:
Y=D means DALI-2 dimming, Y=R means DMX512 dimming.

N8H Series Stadium Lighting LED Driver



Features

- ▶ Input voltage: 180~528Vac;
- ▶ Non-isolated constant power design;
- ▶ D: DALI-2&D4i control + 24V/125mA auxiliary output;
- ▶ R: DMX512-RDM control;
- ▶ M: 0-10V/PWM/Res./Timer dimming + 12V/300mA auxiliary output;
- ▶ Ultra low ripple:<1%@<3kHz&100% load;
- ▶ Standby power consumption <0.5W;
- ▶ DALI-2&D4i: built-in 16V bus power supply;
- ▶ AC Power Metering with High Accuracy up to $\pm 1\%$;
- ▶ NFC Programming;
- ▶ Surge protection: DM 6KV, CM 10KV;
- ▶ All-around protection: Output SCP / OVP/ OPP / OTP;
- ▶ Ingress protection rating: IP67;
- ▶ 5 years warranty.



Application

- ▶ Stadium Lighting, Horticulture Lighting

Product Selection Guide

Model	Power(W)	Output voltage range(Vdc)	Full power output current range(A)	Default output	Typ. Eff.	Typ. PF	Dimensions (L*W*H)mm
N8H-500Y500Z	500	200 ~ 500	1.00 ~ 1.90	1.70A	96.0%	0.97	270*89*42
N8H-680Y500Z	680	200 ~ 500	1.36 ~ 2.60	2.30A	96.0%	0.97	270*89*42
N8H-880Y500Z	880	200 ~ 500	1.76 ~ 3.40	2.00A	97.5%	0.97	303*125*45
N8H-1K0Y500Z	1000	200 ~ 500	2.00 ~ 3.80	2.80A	97.2%	0.97	303*125*45

Note:

1. Y=D&Z=blank means DALI-2 dimming, Y=R&Z=blank means DMX512 dimming;
2. Y=M&Z=A12, 12V/0.2A auxiliary output, 0-10V/PWM/Res. dimming.

X6 Series Stadium Programmable IntelligentLED Driver



Features

- ▶ Input voltage: 90 ~ 305Vac;
- ▶ Isolated constant power design;
- ▶ 3-in-1 dimmable: 0-10V/1-10V/PWM (Dim-to-off optional),
Timers dimming; Reverse dimming optional; Dim-to-off;
- ▶ 3 Timers dimming: Timing; Virtual Midnight; Self-Adaptive;
- ▶ Constant lumen output(CLO);
- ▶ Off-line programmable;
- ▶ Auxiliary output: 12V/0.2A;
- ▶ Surge protection: DM 6KV, CM 10KV;
- ▶ Protections: Output SCP / OVP / OTP;
- ▶ Ingress protection rating: IP67;
- ▶ Suitable for dry / damp / wet locations;
- ▶ 5 years warranty.

SAA FC

Class P

Application

- ▶ Stadium Lighting

Product Selection Guide

Model	Power(W)	Output voltage range(Vdc)	Full power output current range(A)	Default output	Typ. Eff.	Typ. PF	Dimensions (L*W*H)mm
X6-480M060A12	480	30 ~ 60	8.00 ~ 10.00	30 ~ 58V/8.20A	93.5%	0.95	276*125*40
X6-480M268A12	480	134 ~ 268	1.80 ~ 2.40	134 ~ 218V/2.20A	93.5%	0.95	276*125*40
X6-600M056A12	600	27 ~ 56	10.71 ~ 12.50	27 ~ 53V/11.20A	93.0%	0.96	276*144*48
X6-600M060A12	600	30 ~ 60	10.00 ~ 12.50	30 ~ 54V/11.20A	93.0%	0.96	276*144*48
X6-600M134A12	600	67 ~ 134	4.48 ~ 5.60	67 ~ 107V/5.60A	94.0%	0.95	276*144*48
X6-600M268A12	600	108 ~ 268	2.24 ~ 2.80	108 ~ 214V/2.80A	94.5%	0.96	276*144*48
X6-600M428A12	600	240 ~ 428	1.40 ~ 1.75	240 ~ 428V/1.40A	94.5%	0.96	276*144*48
X6-680M056A12	680	38 ~ 56	12.15 ~ 15.00	38 ~ 45V/15.00A	94.0%	0.96	281*135*48

X6H Series Programmable Intelligent LED Driver



Features

- ▶ Input voltage: 198 ~ 528Vac;
- ▶ Isolated constant power design;
- ▶ 3-in-1 dimmable: 0-10V/1-10V/PWM (Dim-to-off optional), Timers dimming; Reverse dimming optional; Dim-to-off;
- ▶ 3 Timers dimming: Timing; Virtual Midnight; Self-Adaptive;
- ▶ Constant lumen output(CLO);
- ▶ Off-line programmable;
- ▶ Auxiliary output: 12V/0.2A;
- ▶ Surge protection: DM 6KV, CM 10KV;
- ▶ Protections: Input UVP, output SCP / OVP / OTP;
- ▶ Ingress protection rating: IP67;
- ▶ Suitable for dry / damp / wet locations;
- ▶ 5 years warranty.



Application

- ▶ Horticulture Lighting, High Power Lighting

Product Selection Guide

Model	Power(W)	Output voltage range(Vdc)	Full power output current range(A)	Default output	Typ. Ef.	Typ. PF	Dimensions (L*W*H)mm
X6H-800M268A12	800	114 ~ 268	3.00 ~ 4.45	114 ~ 268V/2.80A	95.5%	0.97	259*160*50
X6H-1K0M305A12	1000	153 ~ 305	3.28 ~ 4.36	153 ~ 266V/3.75A	95.0%	0.98	341*148*50
X6H-1K2M305A12	1200	153 ~ 305	3.94 ~ 5.25	153 ~ 267V/4.50A	95.0%	0.98	341*148*50

Horticulture Lighting LED Driver



P7 Series 

P1 Series

P1H Series

P6H Series

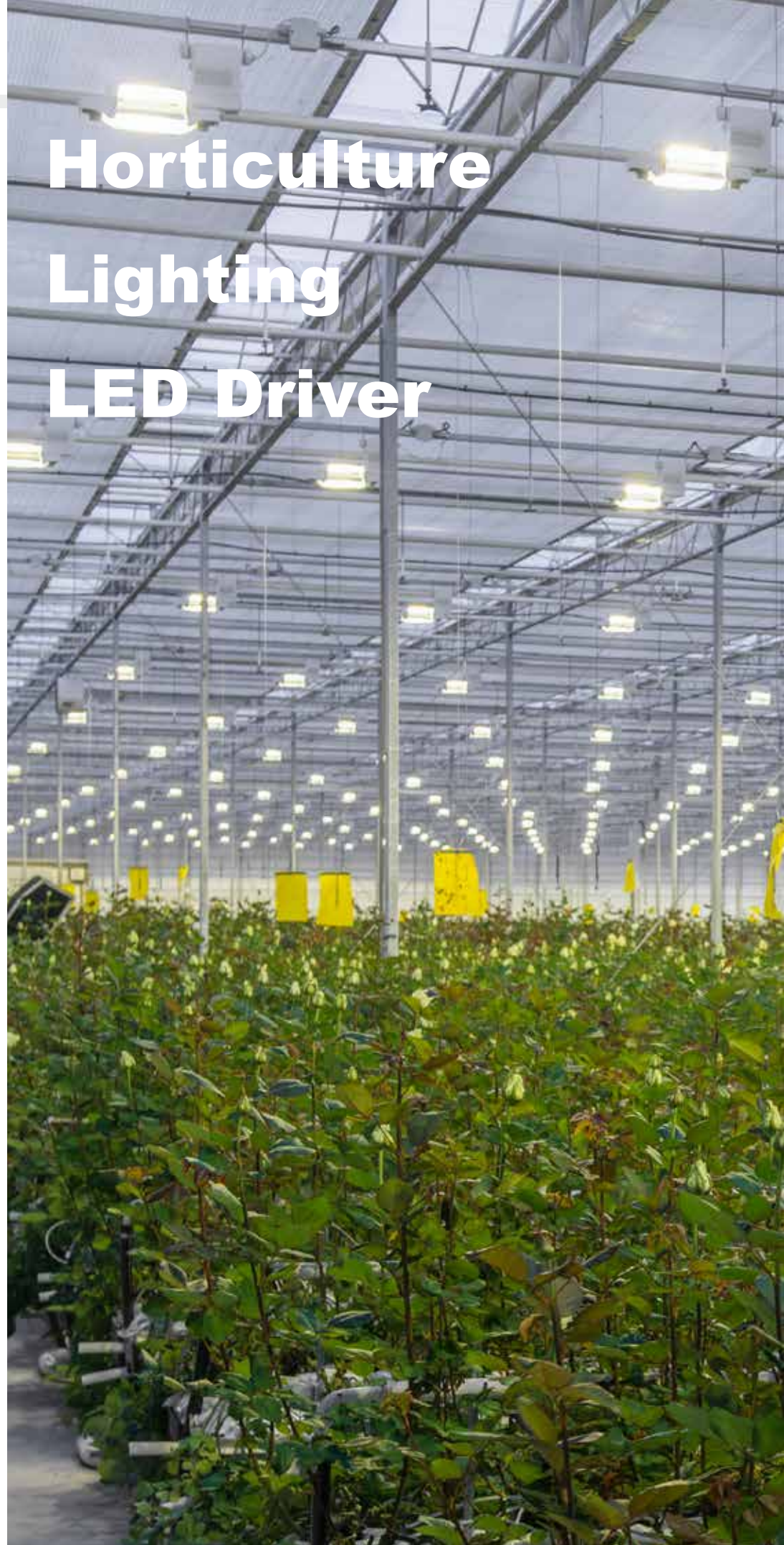

P7 Series Horticulture Lighting Intelligent Driver



Features

- ▶ Input voltage: 90 ~ 305Vac;
- ▶ Isolated constant power design;
- ▶ 3-in-1 dimmable: 0-10V/1-10V/PWM (Dim-to-off optional), Timers dimming; No glow after Dim-to-off;
- ▶ Constant lumen output(CLO);
- ▶ Off-line programmable;
- ▶ Auxiliary output: 12V/0.2A;
- ▶ RJ11+Knob(optional);
- ▶ Surge protection: DM 6KV, CM 10KV;
- ▶ Protections: Output SCP / OVP / OTP / OPP;
- ▶ Ingress protection rating: IP67;
- ▶ Suitable for dry / damp / wet locations;
- ▶ 5 years warranty.



Application

- ▶ Horticulture Lighting, High Power Lighting

Product Selection Guide

Model	Power(W)	Output voltage range(Vdc)	Full power output current range(A)	Default output	Typ. Eff.	Typ. PF	Dimensions (L*W*H)mm
P7-500M056A12	500	30~56	8.92~10.50	48~56V/8.92A	95.0%	0.97	311*89*42
P7-500M056A12RJ	500	30~56	8.92~10.50	48~56V/8.92A	95.0%	0.97	336*89*42
P7-700M056A12	700	30~56	12.50~14.50	48~56V/12.50A	95.0%	0.97	355*89*42
P7-700M056A12RJ	700	30~56	12.50~14.50	48~56V/12.50A	95.0%	0.97	380*89*42
P7-1K0M056A12	1000	30~56	17.86~21.00	48~53V/18.88A	96.0%	0.97	431*89*42
P7-1K0M056A12RJ	1000	30~56	17.86~21.00	48~53V/18.88A	96.0%	0.97	456*89*42

P1 Series Horticulture Lighting Intelligent LED Driver



Features

- ▶ Input voltage: 108 ~ 305Vac;
- ▶ Isolated constant power design;
- ▶ 3-in-1 dimmable: 0-10V/1-10V/PWM (Dim-to-off optional), Timers dimming; No glow after Dim-to-off;
- ▶ 3 Timers dimming: Timing; Virtual Midnight; Self-Adaptive;
- ▶ Constant lumen output(CLO);
- ▶ Off-line programmable;
- ▶ Auxiliary output: 12V/0.2A;
- ▶ Surge protection: DM 6KV, CM 10KV;
- ▶ Protections: Hot plug operation(optional), output SCP / OVP / OTP;
- ▶ Ingress protection rating: IP67;
- ▶ Suitable for dry / damp / wet locations;
- ▶ 5 years warranty.



Class P **Type HL**

Application

- ▶ Horticulture Lighting, High Power Lighting

Product Selection Guide

Model	Power(W)	Output voltage range(Vdc)	Full power output current range(A)	Default output	Typ. Eff.	Typ. PF	Dimensions (L*W*H)mm
P1-320M056A12	320	38 ~ 56	5.72 ~ 6.25	38 ~ 51V/6.25A	93.0%	0.97	285*85*50
P1-400M056A12	400	38 ~ 56	7.15 ~ 8.33	38 ~ 48V/8.33A	94.0%	0.97	285*85*50
P1-600M056A12	600	38 ~ 54	11.11 ~ 11.70	38 ~ 51V/1.70A	94.0%	0.97	301*106*50
P1-680M056A12	680	38 ~ 56	12.15 ~ 14.17	38 ~ 48V/14.17A	94.0%	0.97	341*106*50
P1-680M305A12	680	153 ~ 305	2.23 ~ 2.84	153 ~ 284V/2.40A	95.0%	0.97	341*106*50
P1-800M056A12	800	30 ~ 56	14.29 ~ 16.67	30 ~ 48V/16.67A	95.0%	0.96	381*106*50
P1-800M268A12	800	134 ~ 268	3.00 ~ 4.45	134 ~ 180V/4.45A	95.0%	0.96	381*106*50

Note:

1. M means 0-5V/0-10V/PWM/Timer dimming;
2. A12 means 12V/0.20A or 12V/0.30A auxiliary output;
3. Surge protection:DM 4KV, CM 6KV(320W-400W); DM 5KV, CM 10KV (600W).

P1H Series Horticulture Lighting Intelligent Driver



Class P Type HL

Features

- ▶ Input voltage: 249 ~ 528Vac;
- ▶ Isolated constant power design;
- ▶ 3-in-1 dimmable: 0-10V/1-10V/PWM (Dim-to-off optional), Timers dimming; No glow after Dim-to-off;
- ▶ 3 Timers dimming: Timing; Virtual Midnight; Self-Adaptive;
- ▶ Constant lumen output(CLO);
- ▶ Off-line programmable;
- ▶ Auxiliary output: 12V/0.2A;
- ▶ Surge protection: DM 6KV, CM 10KV;
- ▶ Protections: Hot plug operation(optional), output SCP / OVP / OTP;
- ▶ Ingress protection rating: IP67;
- ▶ Suitable for dry / damp / wet locations;
- ▶ 5~7 years warranty.

Application

- ▶ Horticulture Lighting, High Power Lighting

Product Selection Guide

Model	Power(W)	Output voltage range(Vdc)	Full power output current range(A)	Default output	Typ. Eff.	Typ. PF	Dimensions (L*W*H)mm
P1H-320M056A12	320	38 ~ 54	5.93 ~ 6.25	38 ~ 51V/6.25A	94.0%	0.95	285*85*50
P1H-400M058A12	400	38 ~ 58	6.89 ~ 8.33	38 ~ 48V/8.33A	94.0%	0.95	266*89*42
P1H-600M056A12	600	38 ~ 54	11.11 ~ 11.70	38 ~ 51V/11.70A	95.0%	0.95	301*106*50
P1H-680M305A12	680	153 ~ 305	2.23 ~ 2.84	153 ~ 283V/2.40A	95.0%	0.95	341*106*50

Note:

1. Y=M means 0-5V/0-10V/PWM/Timer dimming;
2. A12 means 12V/0.20A or 12V/0.25A auxiliary output;
3. Surge protection:DM 5KV, CM 10KV (320W);DM 4KV, CM 6KV (600W).

P6H Series Horticulture Lighting Intelligent Driver



Features

- ▶ Input voltage: 198 ~ 440Vac;
- ▶ Non-isolated constant power design;
- ▶ 3-in-1 dimmable: 0-10V/PWM/Res. ; No glow after Dim-to-off;
- ▶ Auxiliary output: 12V/0.2A;
- ▶ Efficiency up to 97%;
- ▶ Inrush current<12A;
- ▶ Surge protection: DM 4KV, CM 6KV;
- ▶ Protections: Output SCP / OVP / OTP;
- ▶ Ingress protection rating: IP20 / IP67;
- ▶ Suitable for dry / damp / wet locations;
- ▶ 5 years warranty.



Type HL

Application

- ▶ Horticulture Lighting, High Power Lighting

Product Selection Guide

Model	Power(W)	Output voltage range(Vdc)	Full power output current range(A)	Default output	Typ. Eff.	Typ. PF	Class of protection	Dimensions (L*W*H)mm
P6H-200M360A12H	200	240 ~ 360	0.56 ~ 0.80	240 ~ 250V/0.80A	95.0%	0.95	333*43*40	333*43*40
P6H-245M360A12	245	200 ~ 360	0.68 ~ 1.00	200 ~ 245V/1.00A	94.0%	0.99	340*43*36	452*43*40
P6H-360M390A12	360	200 ~ 390	0.92 ~ 1.20	200 ~ 300V/1.20A	94.5%	0.99	340*43*36	452*43*40
P6H-400M500A12H	400	250 ~ 500	0.80 ~ 1.40	250 ~ 286V/1.40A	96.0%	0.95	452*43*40	340*43*36
P6H-440M550A12H	440	260 ~ 550	0.80 ~ 1.40	260~314V/1.40A	96.5%	0.98	465*43*36	340*43*36
P6H-550M350A12H	550	175 ~ 350	1.57 ~ 3.00	175~204V/2.70A	95.5%	0.95	452*43*40	465*43*36
P6H-660M550A12H	660	260 ~ 550	1.20 ~ 2.20	260~330V/2.00A	96.5%	0.98	465*43*36	465*43*36

Note:

1. M means 0-10V/PWM/Res.;
2. A12 means 12V/0.20A auxiliary output.

Landscape Lighting LED Driver



V8 Series

V1(LSV) Series

V6E Series

V2 Series

V1R(MSV) Series

V8 Series Constant Voltage LED Driver



Features

- ▶ Input voltage: 180~264Vac;
- ▶ Isolated constant voltage Class II (36-100W) ,design, Class I (150-400W) design;
- ▶ Surge protection: DM 2KV(36W-100W);
CM 1KV, DM 2KV(150W-400W);
- ▶ Protections: Output SCP / OTP / OCP;
- ▶ Ingress protection rating: IP67;
- ▶ suitable for dry / wet / damp locations;
- ▶ 3 years warranty.



Application

- ▶ Landscape Lightin, Advertising Lighting

Product Selection Guide

Model	Power(W)	Output voltage(Vdc)	Output current(A)	Typ. Eff.	Dimensions (L*W*H)mm
V8-036B012	36	12	0 ~ 3.0	87.0%	129*45*17
V8-036B024	36	24	0 ~ 1.5	87.0%	129*45*17
V8-060B012	60	12	0 ~ 5.0	88.0%	129*45*17
V8-060B024	60	24	0 ~ 2.5	87.0%	129*45*17
V8-100B012	100	12	0 ~ 8.33	90.0%	158*45*24
V8-100B024	100	24	0 ~ 4.2	91.0%	158*45*24
V8-150B012	150	12	0 ~ 12.5	87.0%	260*53*24
V8-150B024	150	24	0 ~ 6.25	87.0%	260*53*24
V8-200B012	200	12	0 ~ 16.7	86.0%	282*62*30
V8-200B024	200	24	0 ~ 8.35	87.0%	282*62*30
V8-300B012	300	12	0 ~ 25	91.5%	297*62*30
V8-300B024	300	24	0 ~ 12.5	91.5%	297*62*30
V8-400B012	350	12	0 ~ 29.2	91.5%	312*62*30
V8-400B024	400	24	0 ~ 16.7	91.5%	312*62*30

Note:

B means fixed current , no dimming function.

V1(LSV) Series Constant Voltage LED Driver



Features

- ▶ Input voltage: 90 ~ 305Vac;
- ▶ Isolated constant voltage design;
- ▶ PF>0.96;
- ▶ Surge protection: 35/50W: DM 4KV, CM 6KV;
75~320W: DM 5KV, CM 10KV;
- ▶ Protections: Output SCP / OVP/ OPP / OTP;
- ▶ Ingress protection rating: IP67;
- ▶ Suitable for dry / damp / wet locations;
- ▶ 5 years warranty.

SAA FC

Class P

Application

- ▶ Landscape Lighting, Advertising Lighting

Product Selection Guide

Model	Power(W)	Output voltage (Vdc)	Output current (A)	Typ. Eff.	Typ. PF	Dimensions (L*W*H)mm
LSV-035B012	35	12	0 ~ 2.90	85.0%	0.96	199*43*34
LSV-035B024	35	24	0 ~ 1.46	87.0%	0.96	199*43*34
LSV-035B036	35	36	0 ~ 0.97	87.0%	0.96	199*43*34
LSV-035B048	35	48	0 ~ 0.73	88.0%	0.96	199*43*34
LSV-050B012	50	12	0 ~ 4.17	85.0%	0.96	199*43*34
LSV-050B024	50	24	0 ~ 2.08	88.0%	0.96	199*43*34
LSV-050B036	50	36	0 ~ 1.39	89.0%	0.96	199*43*34
LSV-050B048	50	48	0 ~ 1.04	89.0%	0.96	199*43*34
LSV-075B012	75	12	0 ~ 6.25	87.0%	0.96	164*68*39
LSV-075B024	75	24	0 ~ 3.13	87.0%	0.96	164*68*39
LSV-075B036	75	36	0 ~ 2.08	87.0%	0.96	164*68*39
LSV-075B048	75	48	0 ~ 1.56	87.0%	0.96	164*68*39
LSV-100B012	100	12	0 ~ 8.33	91.0%	0.96	178*68*42
LSV-100B024	100	24	0 ~ 4.17	91.0%	0.96	178*68*42
LSV-100B036	100	36	0 ~ 2.78	92.0%	0.96	178*68*39
LSV-100B048	100	48	0 ~ 2.08	92.0%	0.96	178*68*39
LSV-150B012	150	12	0 ~ 12.5	90.0%	0.96	207*68*42
LSV-150B024	150	24	0 ~ 6.25	91.0%	0.96	207*68*42
LSV-150B036	150	36	0 ~ 4.17	91.0%	0.96	207*68*42
LSV-150B048	150	48	0 ~ 3.13	91.0%	0.96	207*68*42
LSV-200B012	200	12	0 ~ 16.67	91.0%	0.96	232*68*44
LSV-200B024	200	24	0 ~ 8.33	92.0%	0.96	232*68*44
LSV-200B036	200	36	0 ~ 5.56	92.0%	0.96	247*68*44
LSV-200B048	200	48	0 ~ 4.17	92.0%	0.96	247*68*44
LSV-320B012	264	12	0 ~ 22.00	91.0%	0.96	231*98*42
LSV-320B024	320	24	0 ~ 13.33	92.0%	0.96	231*98*42
LSV-320B036	320	36	0 ~ 8.90	92.0%	0.97	231*98*42
LSV-320B048	320	48	0 ~ 6.67	92.0%	0.97	231*98*42

Note:

B means fixed current, no dimming function.

V6E Series Constant Voltage LED Driver



Features

- ▶ Input voltage: 176 ~ 264Vac;
- ▶ Isolated constant voltage design;
- ▶ PF>0.97;
- ▶ THD<10%;
- ▶ Surge protection: DM 6KV, CM 10KV;
- ▶ Protections: Input UVP, Output SCP / OVP/ OPP / OTP;
- ▶ Ingress protection rating: IP67;
- ▶ Suitable for dry / damp / wet locations;
- ▶ 5 years warranty.



Application

- ▶ Landscape Lighting, Advertising Lighting

Product Selection Guide

Model	Power(W)	Output voltage (Vdc)	Output current (A)	Typ. Eff.	Typ. PF	Dimensions (L*W*H)mm
V6E-075B012	75	12	0 ~ 6.25	86.0%	0.99	136*67*37
V6E-075B024	75	24	0 ~ 3.20	88.0%	0.98	136*67*37
V6E-075B036	75	36	0 ~ 2.10	90.0%	0.98	136*67*37
V6E-100B012	100	12	0 ~ 8.34	89.0%	0.97	148*67*37
V6E-100B024	100	24	0 ~ 4.20	89.0%	0.97	148*67*37
V6E-100B036	100	36	0 ~ 2.80	90.0%	0.97	148*67*37
V6E-150B012	150	12	0 ~ 12.50	92.0%	0.97	163*67*37
V6E-150B024	150	24	0 ~ 6.30	93.0%	0.97	163*67*37
V6E-150B036	150	36	0 ~ 4.17	93.0%	0.97	163*67*37
V6E-150B048	150	48	0 ~ 3.12	93.0%	0.97	163*67*37
V6E-200B024	200	24	0 ~ 8.40	93.0%	0.98	176*67*37
V6E-200B036	200	36	0 ~ 5.60	93.0%	0.98	176*67*37
V6E-200B048	200	48	0 ~ 4.17	93.0%	0.97	176*67*37
V6E-240B024	240	24	0 ~ 10.00	93.0%	0.98	194*67*37
V6E-240B036	240	36	0 ~ 6.70	93.0%	0.98	194*67*37
V6E-320B012	320	12	0 ~ 26.70	92.0%	0.98	225*97*42
V6E-320B024	320	24	0 ~ 13.40	93.0%	0.97	225*97*42
V6E-320B048	320	48	0 ~ 6.70	93.5%	0.97	225*97*42
V6E-350B024	350	24	0 ~ 14.60	93.0%	0.98	225*97*42
V6E-350B036	350	36	0 ~ 9.80	93.0%	0.98	225*97*42
V6E-350B048	350	48	0 ~ 7.30	93.5%	0.98	225*97*42
V6E-400B024	400	24	0 ~ 16.70	93.0%	0.98	240*97*42
V6E-400B048	400	48	0 ~ 8.40	94.0%	0.98	240*97*42
V6-600B024	600	24	(0 ~ 12.50)*2	93.0%	0.97	276*144*48
V6-600B048	600	48	0 ~ 12.50	93.0%	0.97	276*144*48

Note:

1. B means fixed current, no dimming function;
2. Input voltage: 90-305Vac (V6-600W).

V2 Series Constant Voltage LED Driver



Features

- ▶ Input voltage: 90 ~ 305Vac;
- ▶ Isolated constant voltage Class 2 design;
- ▶ PF>0.97;
- ▶ Surge protection: DM 4KV, CM 6KV;
- ▶ Protections: Output SCP / OVP/ OPP / OTP;
- ▶ Ingress protection rating: IP67;
- ▶ Suitable for dry / damp / wet locations;
- ▶ 5 years warranty.

Class 2

Application

- ▶ Landscape Lightin, Advertising Lighting

Product Selection Guide

Model	Power(W)	Output voltage (Vdc)	Output current (A)	Typ. Eff.	Typ. PF	Dimensions (L*W*H)mm
V2-060B012	60	12	0~5.0	86.0%	0.95	129*68*35
V2-120B012	120	12	(0-5.0)x2	89.0%	0.95	174*68*35

Note:

B means fixed current, no dimming function.

V1R(MSV) Series Constant Voltage LED Driver



Features

- ▶ Input voltage: 180 ~ 264Vac;
- ▶ Isolated constant voltage design;
- ▶ Structural design: rain-proof design with semi-glue filling;
- ▶ Surge protection: DM 1KV, CM 2KV;
- ▶ All-around protection: SCP/OVP/OPP/OTP;
- ▶ 3 years warranty.

Application

- ▶ Landscape Lighting, Advertising Lighting

Product Selection Guide

Model	Power(W)	Output voltage(Vdc)	Output current(A)	Typ. Eff.	Dimensions (L*W*H)mm
MSV-350B012	350	12	0 ~ 26.67	90.0%	200*130*40
MSV-350B024	350	24	0 ~ 14.60	90.0%	200*130*40
MSV-350B048	350	48	0 ~ 7.30	90.0%	200*130*40
MSV-400B024	400	24	0 ~ 16.67	92.0%	200*130*40
MSV-400B048	400	48	0 ~ 8.33	93.0%	200*130*40

Note:

B means fixed current, no dimming function.

Industrial Power



T Series

Industrial Power

T30-75W Series



Model	MS-T6250J120-075C0 MS-T3200J240-075C0
Input Voltage	90~264Vac/47~63Hz
Output	12V/6.25A, 24V/3.2A
Surge	CM: 4KV;DM: 2KV
Ripple P-P(mV)	200
Dimension(mm)	104*97*29.5
Safety	CE

T30-100W Series



Model	T30-T8330J120-100A0 T30-T4170J240-100A0
Input Voltage	90~264Vac/47~63Hz
Output	12V/8.33A, 24V/4.17A
Surge	CM: 4KV; DM: 2KV
Ripple P-P(mV)	200
Dimension(mm)	129*97*30
Safety	CE/CB/UL/CQC/SAA/ FCC/UKCA/KC

T30-150W Series



Model	MS-TA250J120-150A0 MS-T6500J240-150A0 MS-T3130J480-150A0
Input Voltage	100~120Vac or 200~240Vac 47~63Hz(Adjust by switch)
Output	12V/12.5A, 24V/6.5A, 48V/3.13A
Surge	CM: 4KV;DM: 2KV
Ripple P-P(mV)	300
Dimension(mm)	159*97*30
Safety	CE

T30-150W Series



Model	T30-T6500J240-150B0
Input Voltage	90~264Vac/47~63Hz
Output	24V/6.5A
Surge	CM: 4KV; DM: 2KV
Ripple P-P(mV)	200
Dimension(mm)	159*97*30
Safety	CB/CE/UKCA/CQC/UL/ FCC/SAA

T40-250W Series



Model	T40-TA042J240-250E0
Input Voltage	90~264Vac/47~63Hz
Output	24V/10.42A
Surge	CM: 4KV;DM: 2KV
Ripple P-P(mV)	200
Dimension(mm)	159*97*30
Safety	CB/CE/UKCA/CQC/UL/ FCC/SAA
PF	>0.95

T30-350W Series



Model	MSA-TA460DR240-350A0 MS-T7290A480-350A0
Input Voltage	100~120Vac or 200~240Vac 47~63Hz(Adjust by switch)
Output	24V/14.6A, 48V/7.29A
Surge	CM: 4KV; DM: 2KV
Ripple P-P(mV)	200
Dimension(mm)	215*115*29
Safety	CB/CE/UL/CQC/FCC

T40-350W Series



Model	T40-TA460J240-350F0
Input Voltage	90~264Vac/47~63Hz
Output	24V/14.6A
Surge	CM: 4KV;DM: 2KV
Ripple P-P(mV)	200
Dimension(mm)	215*115*29
Safety	CB/CE/UL/CQC/FCC/SAA
PF	>0.95

T30-500W Series



Model	MS-TB100J240-500C0
Input Voltage	90~264Vac/47~63Hz
Output	24V/21A
Surge	CM: 4KV; DM: 2KV
Ripple P-P(mV)	200
Dimension(mm)	230*127*40
Safety	CB/CE/UKCA/UL/FCC
PF	>0.95

T30-650W Series



Model	MS-TB2710J240-800A0
Input Voltage	90~264Vac/47~63Hz
Output	24V/27.1A
Surge	CM: 4KV;DM: 2KV
Ripple P-P(mV)	240
Dimension(mm)	218*116.5*40.5
Safety	CE/CQC
PF	>0.95

T30-1800W Series



Model	T30-TE000J360-K80A0
Input Voltage	90~264Vac/47~63Hz
Output	36V/50A@230Vac 36V/25A@115Vac
Surge	CM: 4KV; DM: 2KV
Ripple P-P(mV)	360
Dimension(mm)	300*199.2*81
Safety	/
PF	>0.95

Urban Public Lighting LED Driver



X6 D Series

X6 VS Series

X6 DS Series

X6D Series DALI-2 Programmable Intelligent LED Driver



Application

- ▶ Rail Transit Lighting, Commercial Lighting

Product Selection Guide

Model	Power(W)	Output voltage range(Vdc)	Full power output current range(A)	Default output	Typ. Eff.	Typ. PF	Dimensions (L*W*H)mm
X6-012D048	12	28 ~ 48	0.25 ~ 0.33	28 ~ 36V/0.33A	86.0%	0.95	120*64*33
X6-018D048	18	28 ~ 48	0.40 ~ 0.50	28 ~ 36V/0.50A	87.0%	0.95	120*64*33
X6-026D048	26	28 ~ 48	0.54 ~ 0.73	28 ~ 36V/0.73A	87.0%	0.95	120*64*33
X6-036D048	36	28 ~ 48	0.80 ~ 1.00	28 ~ 36V/1.00A	87.0%	0.95	120*64*33
X6-042D048	42	28 ~ 48	0.88 ~ 1.17	28 ~ 36V/1.17A	87.0%	0.95	120*64*33
X6-054D048	54	28 ~ 48	1.10 ~ 1.50	28 ~ 36V/1.50A	87.0%	0.95	120*64*33

Note: D means DALI-2 & Timer dimming.

Features

- ▶ Input voltage: 100 ~ 264Vac;
- ▶ Isolated constant current design;
- ▶ Dimmable: DALI-2, Dim-to-off;
- ▶ Output and Dimming Signal Isolating;
- ▶ Standby power consumption<0.5W;
- ▶ Surge protection: DM 2KV, CM 4KV;
- ▶ Protections: Input UVP, output SCP / OVP / OTP;
- ▶ Ingress protection rating: IP65;
- ▶ Suitable for dry / damp / wet locations;
- ▶ 5 years warranty.

X6 VS Series Intelligent LED Driver



Application

- ▶ Rail Transit Lighting , Commercial Lighting

Product Selection Guide

Model	Power(W)	Output voltage range(Vdc)	Adjustable output current range(A)	Default output	Typ. Eff.	Typ. PF	Dimensions (L*W*H)mm
X6-012V048-S	12	24 ~ 48	0.15 ~ 0.30	0.24A	86.0%	0.97	143*43*36
X6-020V048-S	20	24 ~ 48	0.25 ~ 0.50	0.45A	88.0%	0.97	143*43*36
X6-036V048-S	36	24 ~ 48	0.50 ~ 0.95	0.88A	88.0%	0.97	143*43*36

Features

- ▶ Input voltage: 176 ~ 264Vac;
- ▶ Isolated constant current design;
- ▶ Output current adjustable by built-in potentiometer;
- ▶ THD:typ 5%
- ▶ Surge protection: DM 2KV, CM 4KV;
- ▶ Protections: Input UVP, output SCP / OVP / OTP;
- ▶ Ingress protection rating: IP65;
- ▶ Suitable for dry / damp / wet locations;
- ▶ 5 years warranty.

X6 DS Series DALI-2 Programmable Intelligent LED Driver



Application

- ▶ Rail Transit Lighting , Commercial Lighting

Product Selection Guide

Model	Power(W)	Output voltage range(Vdc)	Full power output current range(A)	Default output	Typ. Eff.	Typ. PF	Dimensions (L*W*H)mm
X6-012D048-S	12	24 ~ 48	0.25 ~ 0.30	0.24A	86.0%	0.97	143*43*36
X6-020D048-S	20	24 ~ 48	0.42 ~ 0.50	0.45A	88.0%	0.97	143*43*36
X6-036D048-S	36	24 ~ 48	0.75 ~ 0.95	0.88A	88.0%	0.97	143*43*36

Features

- ▶ Input voltage: 176 ~ 264Vac;
- ▶ Isolated constant current design;
- ▶ Dimmable: DALI-2, Dim-to-off;
- ▶ Output and Dimming Signal Isolating;
- ▶ Standby power consumption<0.5W;
- ▶ Surge protection: DM 2KV, CM 4KV;
- ▶ Protections: Input UVP, output SCP / OVP / OTP;
- ▶ Ingress protection rating: IP65;
- ▶ Suitable for dry / damp / wet locations;
- ▶ 5 years warranty.

10KV Surge Protection Device



Application

- ▶ Used for indoor or outdoor electrical protection

Product Selection Guide

Model	Combination wave(KV)	Nominal discharge current(KA)	Level of voltage protect(KV)	Sectional area of mounting	Dimension(L*W*H)mm
MSP-10K-SURGE	10	5	<1.3	3*1.0mm ²	82*38*16
MS-10KV-SPD	10	5	<1.5	3*1.0mm ²	62*35*36

Features

- ▶ CLASS I installation method;
- ▶ Meet the requirements of EN61643-11 standard;
- ▶ Built-in failure protection, better security performance;
- ▶ Three-wire series connection is adopted;
- ▶ Suitable for LED driver surge protection;
- ▶ Ingress protection rating: IP67.

Configuration Connection Scheme

► For DALI-2 programmer

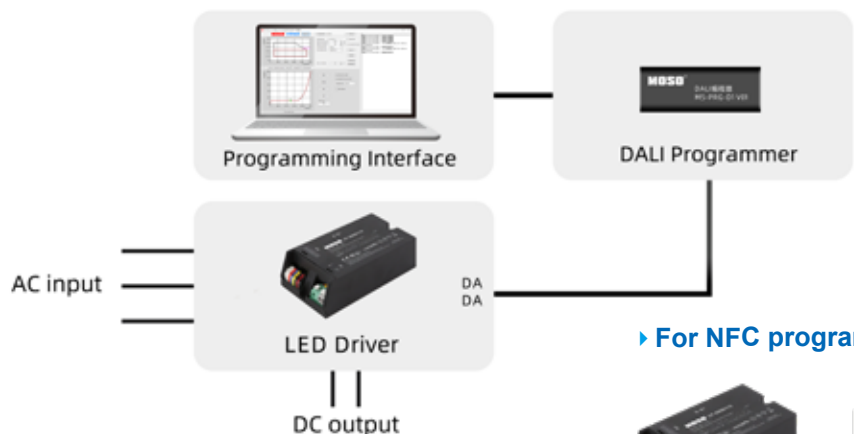

► For NFC programmer



Visual Software Operation Interface

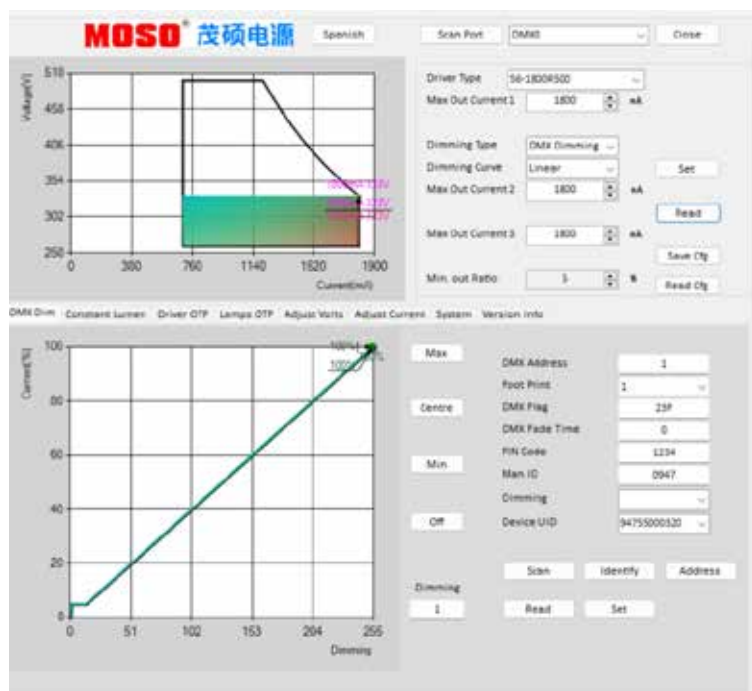

LED Driver Configurer Tool Programming Description

1. Chinese and English version interfaces, online upgrade automatically;
2. The maximum output power and current, dimming type and dimming curve can be set;
3. The current parameters and configured driving parameters can be read;
4. Timer dimming. Set the time control function, which supports up to 7 segments;
5. Constant Lumen Output (CLO);
6. Driver OTP and Lamps OTP parameters can be set according to customers' needs.

Off-line Programming

User-friendly programming connection without the need to power on the driver. Suitable for X6, XCP, X6E, X7P, P1, P1H, X6H, G5(MTP) series, etc.

Programming mode 1



Suitable for Windows operating system

Programming mode 2



One-button Programming Description

1. Open the software interface and download the data to the one-button programmer;
2. Connect the dimming wire to the one-button programmer, press the program button, the programmer will give you a reminder "(beep)" to tell you that the installation is that the programming is complete.

Visual Software Operation Interface

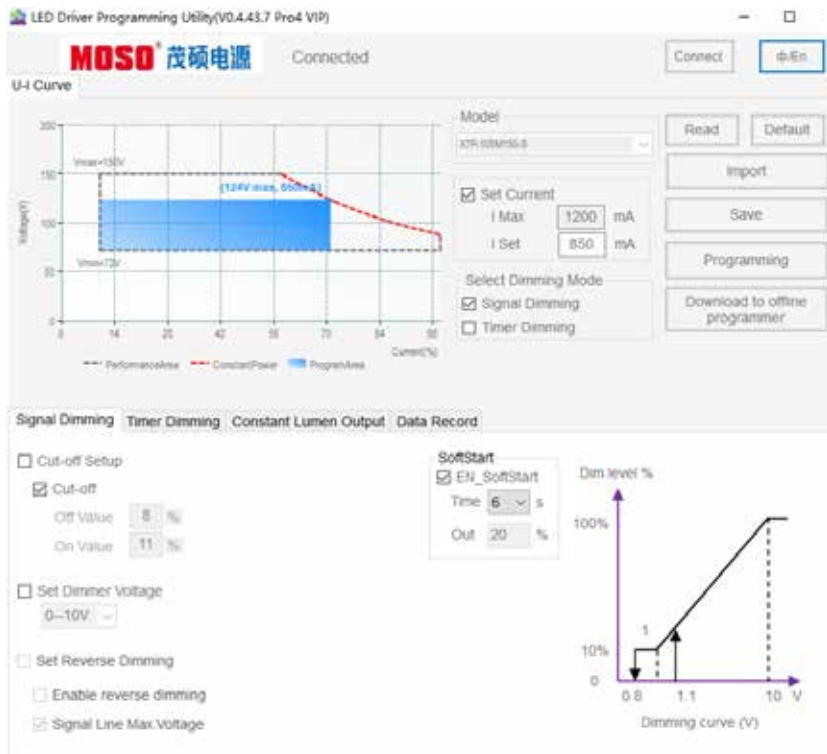

Off-line Programming Description

1. Set the Dimmer Voltage: 0-3.3V/0-5V/0-9V/0-10V optional;
2. Timer dimming. Set the timer control function, support up to 7 segments;
3. Constant Lumen Output (CLO);
4. Read the recorded data: Total Working time, working temperature and Firmware version;
5. Configure the driver parameters. After the setting is completed, click the Programming button to program the driver;
6. Download to the Offline Programmer.

Global Distributors

Country	Distributor	Tel	Website	Address
Asia	Future Electronics	+65 6594 5000	www.futureelectronics.com	8 Changi Business Park Avenue 1 #06-51 ESR BizPark @ Changi (South Tower) Singapore
Italy	Stelium Technology Italy S.p.A.	+39 05530 2631	https://www.stelium.it/en	Stelium Technology Italy SpA, Via della Treccia 33 - 50145 Firenze, Italy
Poland	MPL Power Elektro SP.z.o.o.	+48 32440 0950	www.mplpower.pl	Zabrze ul. Handlowa 13, 41-807 Zabrze
Spain	INELEC, S.A.	+ 34 91726 3508	www.inelec.net	C/ Bocángel, 38, 28028 Madrid
Northern Europe	VALOPAS OY	+358 50500 8092	www.valopas.fi	Kurkkulantie 39, 31460 Hirsjärvi, FINLAND
Russia	ECOMP Ltd.	+7 800 770-74-44	https://e-components.ru	196247, Russia, Saint-Petersburg, pl. Konstitutii, 3A, pom. 15H(513, 517)
Russia, Belarus, Kazakhstan	LLC "VM Komponenty"	+7 (495) 252-07-77	https://www.platan.ru	125284, Moscow, Begovaya street, building 6A
Russia	"MicroEM" JSC	+7 495 739 65 39	https://microem.ru	Savjolkinskij proezd, bld.4, floor 9, Zelenograd, Moscow, Russia, 124482
Argentina	Arrow Argentina	+54 114 122 3544	www.arrow.com	La Pampa 1391, 6P of 1Buenos Aires, C1428DZA, Argentina
Brazil	ITECH COM	+55 (11) 3350-0200	https://grupoitech.com.br	Al . Barão de Piracicaba, 695- São Paulo - SP - Brasil-01216-012
India	Power Palazzo Pvt Ltd	+91 9099003077	https://powerpalazzo.com/	B-402 Safal Pegasus, Nr Auda Garden, Anandnagar Road, Prahalad Nagar, Satellite, Ahmedabad, Gujarat 380051, India
India	Semiconic Devices Pvt. Ltd	+91 8920341349	www.semiconic.com	B-145, B- Block, Phase-II, Gautam Budha Nagar, Noida, UP-201301, India
USA	Starux, Inc.	+1 201 720 7781	www.starux.com	700 Kinderkamack Rd, Ste 309 Oradell, NJ 07649.
USA	SunLux (Elite LED Supply)	+1 7134706835	www.sunluxusa.com	5710 W. 34th St. Suite B Houston, TX 77092
Middle East	Sarnikon Metal Ve Elektronik A.Ş.	+90 216 471 7197	www.sarnikon.com	Eyüp Sultan Mah. İbni Sina Cd. No:22 Sancaktepe/ İSTANBUL-34885 Türkiye
Middle East	Zenit Led Aydınlatma Ve Teknolojileri A.Ş.	+90 216 591 0035	www.zenit.com.tr	Deri OSB Mh.Yan San. Cad.17 Deri Osb Sit.YA-11 No: 17/1/2 34956 Tuzla / İSTANBUL, Türkiye
Egypt	Global Automation for LED Manufacturing	+20 1092300079	https://globalautomationeg.com	Cairo, 1ST FLOOR –WEST SOUTH INDUSTRIAL REGION A6, 10TH OF RAMADAN, SHARKIA, EGYPT

Product Model Naming Rules

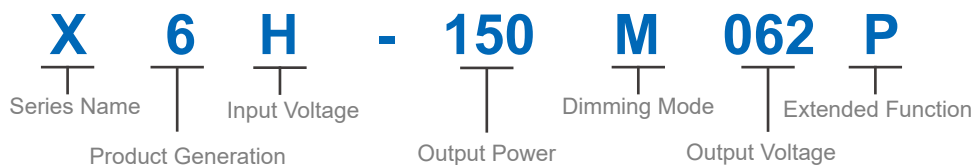

Series Name:

- X: Road Lighting Series;
- G: Round Industrial Lighting Series;
- N: Linear Industrial Lighting Series;
- A: Explosion-proof Lighting Series;
- S: Stadium Lighting Series;
- P: Horticulture Lighting Series;
- V: Landscape Lighting Series;

Product Generation:

For example: 6 means the 6th generation product;

Input Voltage:

- Blank: 100-277Vac;
- P: 100-240Vac;
- E: 220-240Vac;
- C: 120-347Vac;
- H: 230/277-480Vac;
- I: Indian market;
- S: Class II power supply;

Output Power:

- 075:75W;
- 150:150W;
- 1K2:1200W;

Dimming Mode:

- M: 0-10V/PWM dimming;
- D: DALI dimming;
- V: Potentiometer adjusts current, no dimming function;
- B: Fixed current output, no dimming function;
- P: PLC dimming;
- R: DMX512 dimming;

Output Voltage:

- 062: output maximum voltage 62V;

Extension Function:

- A12: 12V auxiliary output;
- F: Large case/flicker;
- P: UL wire;
- RJ: RJ Connector;
- A: Forward;
- B: Reverse;
- EN: Enhance, derivative Enhanced Edition.

MOSO[®]



Technology Innovation and Product Supremacy



Tel: +86-755-27657000
Fax: +86-755-27657908



E-mail: info@mosopower.com



<https://led.mosopower.com>



Headquarter Address: MOSO Industrial Park, Xili Town,
Nanshan District, Shenzhen, China(518108)